

# **SIGNAMAX**

**065-7410GPOEP**

---



## **User Manual**

**Last Update: July 8, 2015**

**Version 1.0**

© Copyright 2015 Signamax, Inc.

All Rights Reserved

This document contains information, which is protected by copyright. Reproduction, adaptation or translation without prior permission is prohibited, except as allowed under the copyright laws.

### **Trademark Information**

Signamax Connectivity Systems is a registered trademark of Signamax, Inc., Microsoft Windows and the Windows logo are the trademarks of Microsoft Corp. NetWare is the registered trademark of Novell Inc. WMM and WPA are the registered trademarks of Wi-Fi Alliance. All other brand and product names are trademarks or registered trademarks of their respective owners.

Notice: Copyrights © 2015 by Signamax, Inc. All rights reserved. Reproduction, adaptation, or translation without prior permission of Signamax, Inc. is prohibited, except as allowed under the copyright laws.

### **Disclaimer**

Signamax, Inc. provides this manual without warranty of any kind, expressed or implied, including but not limited to the implied warranties of merchantability and fitness for a particular purpose. Signamax, Inc. may make improvements and/or changes to the product and/or specifications of the product described in this manual, without prior notice. Signamax, Inc. will not be liable for any technical inaccuracies or typographical errors found in this guide. Changes are periodically made to the information contained herein and will be incorporated into later versions of the manual. The information contained is subject to change without prior notice.

## **FCC Notice**

This equipment has been tested and found to comply with the limits for a Class-A digital device, pursuant to Part 15 of the FCC rules. These limits are designed to provide reasonable protection against harmful interference in a residential installation. This equipment generates, uses, and can radiate radio frequency energy. It may cause harmful interference to radio communications if the equipment is not installed and used in accordance with the instructions. However, there is no guarantee that interference will not occur in a particular installation. If this equipment does cause harmful interference to radio or television reception, which can be determined by turning the equipment off and on, the user is encouraged to try to correct the interference by one or more of the following measures:

- Reorient or relocate the receiving antenna.
- Increase the separation between the equipment and receiver.
- Connect the equipment into an outlet on a circuit different from that to which the receiver is connected.
- Consult the dealer or an experienced radio/TV technician for help.

Caution: Any changes or modifications not expressly approved by the grantee of this device could void the user's authority to operate the equipment.

## **CE Mark Warning**

This is a Class-A product. In a domestic environment this product may cause radio interference in which case the user may be required to take adequate measures.

Industrial Ethernet Switches

Industrial Grade Gigabit Unmanaged Ethernet Switches

User Manual

Version 1.0 (August 2014)

This manual supports the following models:

- 065-7410GPOEP

This document is the current official release manual. Please check our website ([www.signamax.com](http://www.signamax.com)) for any updated manual or contact us by e-mail ([sales@signamax.com](mailto:sales@signamax.com)).

# Contents

Overview.....	1
Key Features.....	1
Package Contents .....	2
Safety Precaution .....	2
Hardware Description .....	3
Physical Dimensions .....	3
Front Panel.....	4
Top View.....	4
LED Indicators.....	5
Ethernet Ports .....	5
Cabling .....	7
Wiring the Power Inputs.....	9
Wiring the Fault Alarm Contact .....	10
Mounting Installation.....	11
DIN-Rail Mounting.....	11
Wall Mounting.....	12
Hardware Installation.....	14
Installation Steps .....	14
Trouble Shooting.....	15
Technical Specification .....	16

The Signamax 065-7410GPOEP is an Industrial Gigabit unmanaged Ethernet switch with an IP30 rating and a pre-installed DIN-Rail mount. It has eight IEEE 802.3at compliant ports (30W/port) and two dual-rate (100/1000) SFP slots, suitable for applications that require high bandwidth and long distance communication.

In order to prevent unregulated voltage, this product provides high EFT and ESD protection. This also allows it to function in harsh environments, as well as support power redundancy with a dual power input design with reverse polarity protection. The built-in relay warning function alerts users about power failures that occur.

This model has a wide operating temperature of -40°F ~ 167°F (-40°C ~ 75°C), and is designed to meet any needs for industrial automation, outdoor application and harsh environments.

## Key Features

### Interface & Performance

- All Copper ports support auto MDI/MDI-X function
- Embedded 8\*10/100/1000BaseT/TX ports (PSE 30W/Port) and two (2) 100/1000Base SFP Slots
- Store-and-forward switching architecture
- 8K MAC Address Table
- Supports 9.6 Kbytes Jumbo Frame
- 2,000 V DC Power line EFT protection & 6000 V DC Ethernet ESD protection

### Power Input

- DC 48 ~ 55V redundant power

### Operating Temperature

- Extended operating temperature: -40°F ~ 167°F (-40°C ~ 75°C)

### Case/Installation

- IP30 protection
- Installation in pollution degree to environment
- DIN-Rail and wall mount design

## Package Contents

- 1 - 065-7410GPOEP 10-port industrial PoE+ gigabit unmanaged Ethernet switch
- 1 - User manual
- 1 - Product CD
- 2 - Wall mounting brackets and screws
- 1 - DC cable –18 AWG & DC jack 5.5x2.1mm

## Safety Precaution

### **Attention**

If the DC voltage is supplied by an external circuit, please use a protection device on the power supply input. The industrial Ethernet switch's hardware specs, ports, cabling information, and wiring installation will be described within this user manual.

# Hardware Description

## Physical Dimensions

Figure 2.1, below, shows the physical dimensions of the 065-7410GPOEP 10-port industrial PoE+ gigabit unmanaged Ethernet switch.

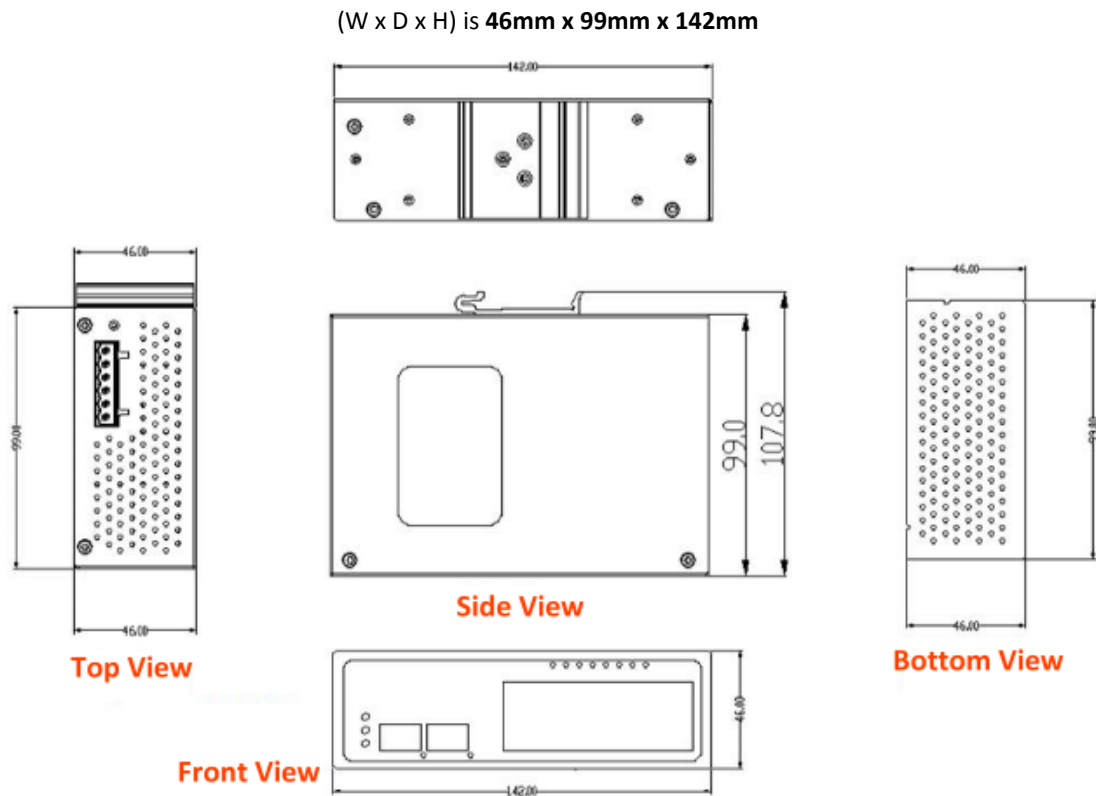

Figure 2.1: 065-7410GPOEP Physical Dimensions

## Front Panel

The front panel of the 065-7410GPOEP Industrial PoE+ Gigabit unmanaged Ethernet switch is shown below in Figure 2.2.



Figure 2.2: The Front Panel of 065-7410GPOEP

## Top View

Figure 2.3, below, shows the top panel of the 065-7410GPOEP switch that is equipped with one 6-pin removal terminal block connector for dual DC power inputs (48~55VDC).

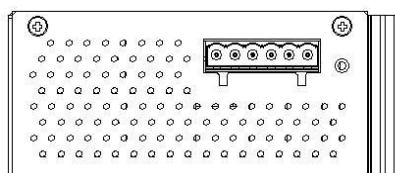

Figure 2.3: Top Panel View of 065-7410GPOEP



## LED Indicators

There are LED light indicators located on the front panel of the 065-7410GPOEP switch that display the power status and network status. Each LED indicator has a different color and has its own specific meaning, see below in Table 2.1.



LED	Color	Description	
P1	Green	On	Power input 1 is active
		Off	Power input 1 is inactive
P2	Green	On	Power input 2 is active
		Off	Power input 2 is inactive
Fault	Green	On	Power input 1 or 2 is inactive
	Red	Off	Power input 1 and 2 are both functional, or no power, inputs/ports link is active/port alarm is disabled
PoE Indicators (Port 1-8)	Green	On	The port is supplying power to the powered-device
		Off	No powered-device attached or power supplying fails
LNK/ACT (SFP Port)	Green	On	Connected to network
		Flashing	Networking is active
		Off	Not connected to network
LAN Port 1-8 (Left LED)	 Green	On	Connected to network, 1000Mbps
		Flashing	Networking is active
		Off	Not connected to network
LAN Port 1-8 (Right LED)	 Green	On	Connected to network, 100Mbps/10Mbps
		Flashing	Networking is active
		Off	Not connected to network

Table 2.1: LED Indicators for 065-7410GPOEP

## Ethernet Ports

### RJ-45 Ports(Auto MDI/MDIX)

The RJ-45 ports are auto-sensing for 10BaseT, 100BaseTX or 1000BaseT device connections. Auto MDI/MDIX means that the switch can connect to another switch or workstation without changing the straight-through or crossover cabling. See the figures as below for straight-through and crossover cabling schematics.

**RJ-45 Pin Assignments** (Table 2.2)

Pin Number	Assignment
1	Rx+
2	Rx-
3	Tx+
6	Tx-

Table 2.2: RJ-45 Pin Assignments

**Note:** “+” and “-” signs represent the polarity of the wires that make up each wire pair.

All ports on this industrial Ethernet switch support automatic MDI/MDI-X operation. Users can use straight-through cables (see Figure 2.4) for all network connections to PCs, servers, other switches or hubs. With straight-through cable, pins 1, 2, 3, and 6, at one end of the cable, are connected straight through to pins 1, 2, 3 and 6 at the other end of the cable. The table below (Table 2.3) shows the 10BASE-T, 100BASE-TX, 1000BASE-TX MDI and MDI-X port pin outs.

Pin MDI-X	Signal Name	MDI Signal Name
1	Receive Data plus (RD+)	Transmit Data plus (TD+)
2	Receive Data minus (RD-)	Transmit Data minus (TD-)
3	Transmit Data plus (TD+)	Receive Data plus (RD+)
6	Transmit Data minus (TD-)	Receive Data minus (RD-)

Table 2.3: Ethernet Signal Pin Outs

The following figures show the cabling schematics for straight-through and crossover.

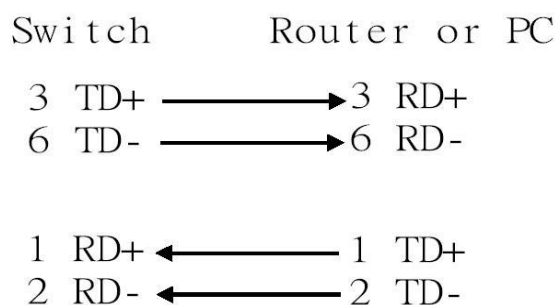

Figure 2.4: Straight-Through Cable Schematic

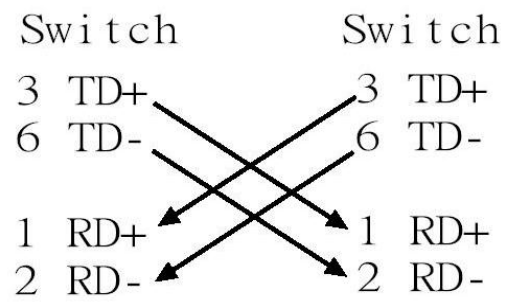

Figure 2.5: Crossover Cable Schematic

The following figures show the 10,100, and 1000 Ethernet RJ-45 pin outs.

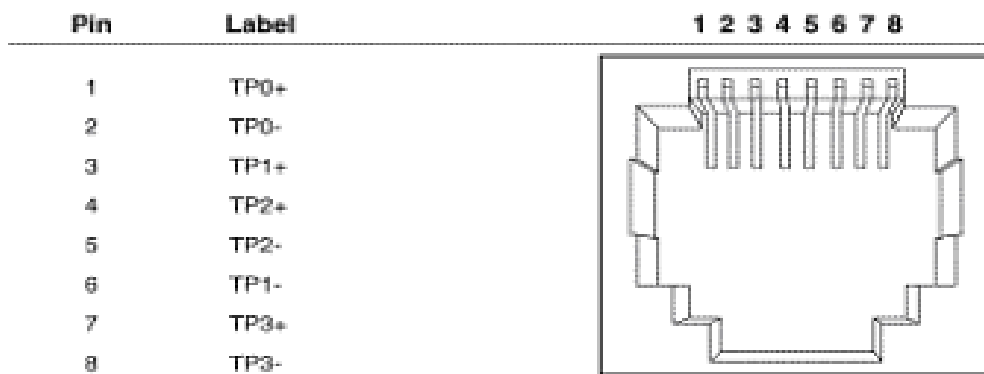
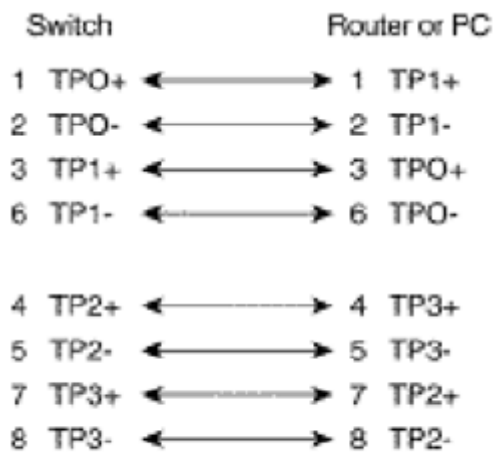
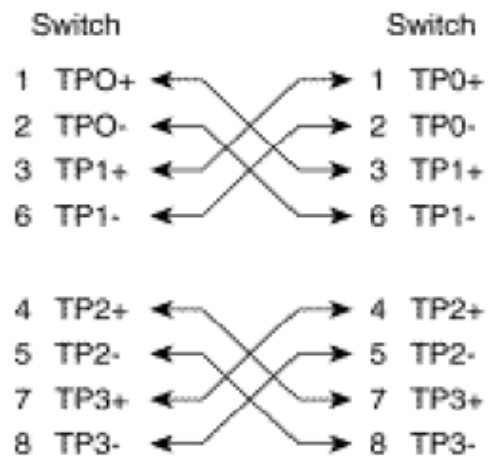

Figure 2.6: RJ45 Ethernet Port Pin Outs



Straight through cables schematic

Figure 2.7: Straight-Through Cable Schematic



Cross over cables schematic

Figure 2.8: Crossover Cable Schematic

## Cabling

Use the four twisted-pair, category 5e, or the above cabling for RJ-45 port connections. The cable between the switch and the link partner (switch, hub, workstation, etc.) must be less than 100 meters (328 ft.) long.

The small form-factor pluggable (SFP) is a compact optical transceiver used in optical communications for both telecommunication and data communication applications.

To connect the transceiver and LC cable, please follow below steps:

- Step 1 Insert the SFP transceiver module into the SFP slot as shown below in Figure 2.9. Notice that the triangle mark is at the bottom of the SFP slot. Figure 2.10 shows SFP transceiver module was inserted.

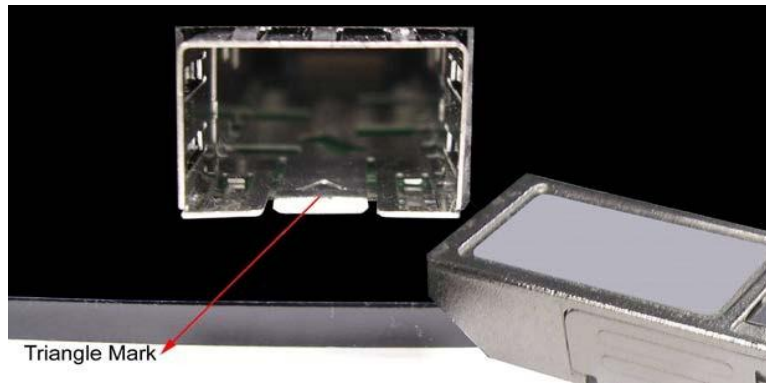

Figure 2.9: Transceiver to the SFP Module



Figure 2.10: Transceiver Inserted

Step 2 Insert the fiber cable of the LC connector into the transceiver as shown below in Figure 2.11.

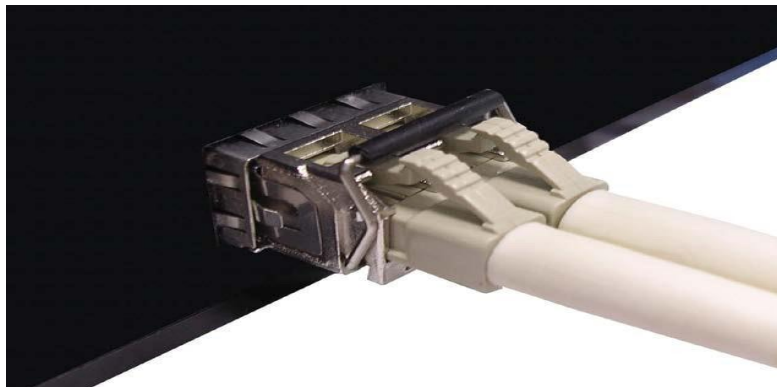

Figure 2.11: LC Connector to the Transceiver

To remove the LC connector from the transceiver, please follow the steps shown below:

Step 1 Press the upper side of the LC connector from the transceiver and pull it out to release as shown below in Figure 2.12

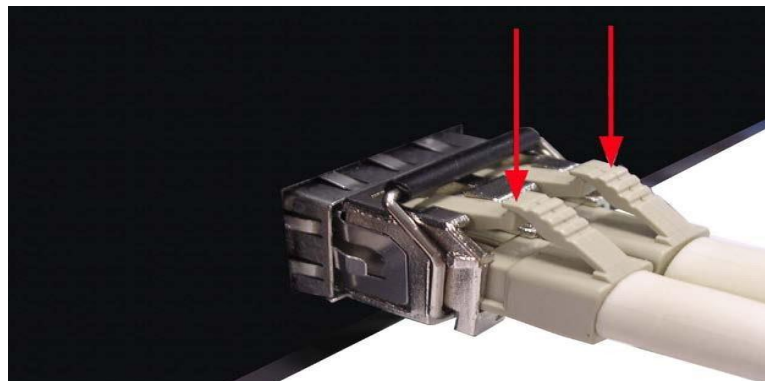

Figure 2.12: Remove LC Connector

Step 2 Push down the metal clasp and pull the transceiver out by the plastic part as shown below in Figure 2.13

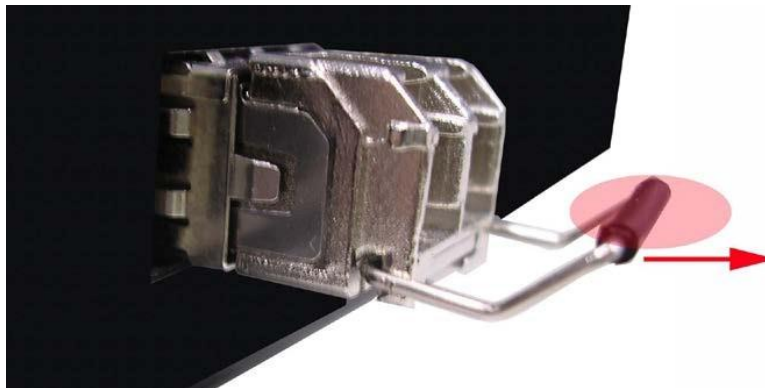

Figure 2.13: Pull Out from the SFP Module

## Wiring the Power Inputs

Please follow the below steps to insert the power wire.

Step 1 Insert the positive and negative wires into the PWR1 (V1+, V1-) and PWR2 (V2+, V2-) contacts on the terminal block connector as shown below in Figure 2.14.

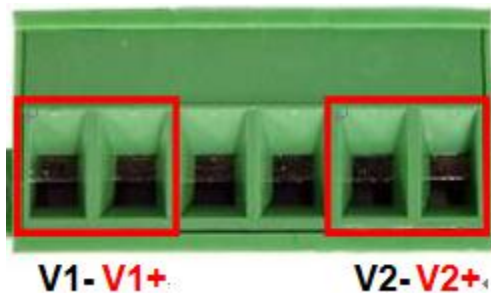

Figure 2.14: Power Terminal Block

Step 2 Tighten the wire-clamp screws to prevent the wires from loosening, as shown below in Figure 2.15.



Figure 2.15: Power Terminal Block

**Note:** Only use copper conductors, **60/75°C**, tighten to **5 lbs.**  
The wire gauge for the terminal block should range between **18~20 AWG**.

### Wiring the Fault Alarm Contact

The fault alarm contact is in the middle of the terminal block connector as the picture shows below in Figure 2.16. By inserting the wires, it will detect the fault status including power failure or port link failure (managed industrial switch only) and form a normally open circuit. An application example for the fault alarm contact is shown below in Figure 2.16.

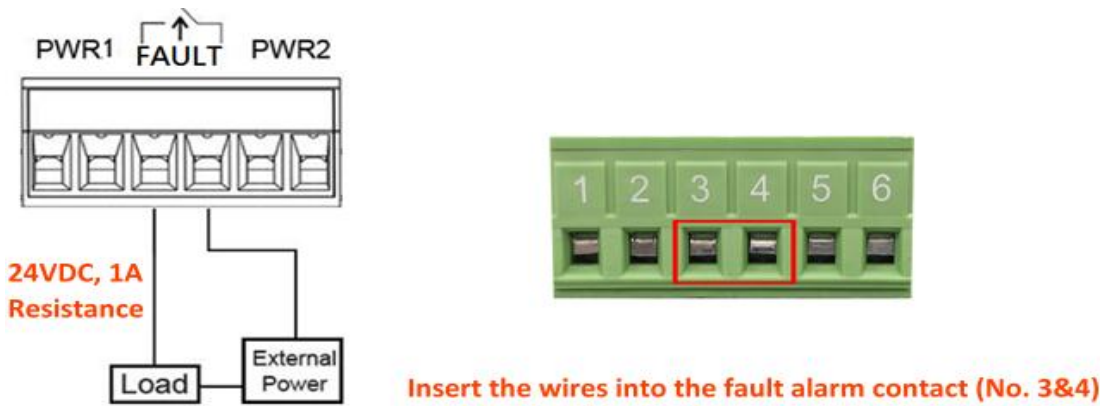

Figure 2.16: Wiring the Fault Alarm Contact

**Note:** The wire gauge for the terminal block should range between **12 ~ 24 AWG**.  
**If only using one power source, jumper Pin 1 to Pin 5 and Pin 2 to Pin 6 to eliminate a power fault alarm.**

# Mounting Installation

## DIN-Rail Mounting

The DIN-Rail is pre-installed on the 065-7410GPOEP switch at the factory. If the DIN-Rail is not on the industrial Ethernet switch, please see Figure 3.1 to learn how to install the DIN-Rail on the switch.

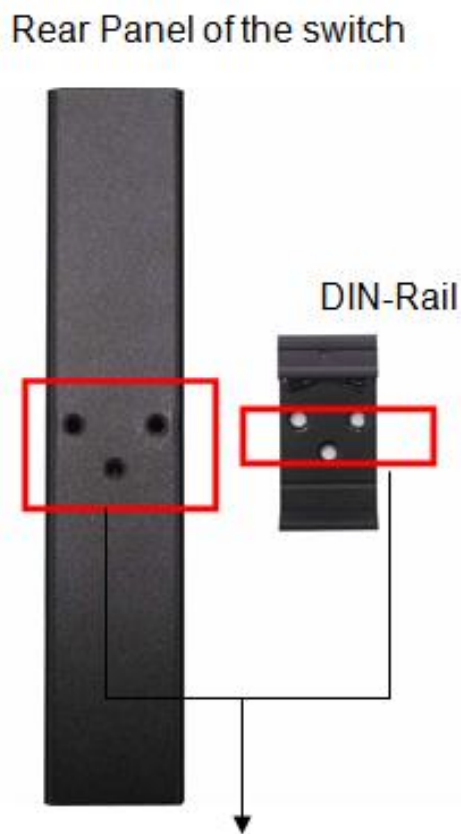

Figure 3.1: The Rear Side of the Switch and DIN-Rail Bracket

Follow the steps below to learn how to mount the industrial Ethernet switch.

- Step 1 Use the screws to install the DIN-Rail bracket on the rear side of the industrial Ethernet switch.
- Step 2 To remove the DIN-Rail bracket, do the opposite from Step 1.
- Step 3 After the DIN-Rail bracket is installed on the rear of the switch, insert the top of the DIN-Rail on to the track as shown below in Figure 3.2.



Figure 3.2: Insert the Switch on the DIN-Rail

Step 4 Lightly pull down the bracket on to the rail as shown below in Figure 3.3.

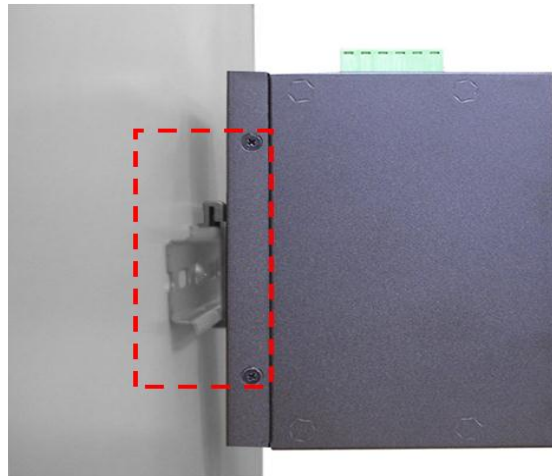

Figure 3.3: Stabilize the Switch on the DIN-Rail

Step 5 Check if the bracket is mounted tightly on the rail.

Step 6 To remove the industrial Ethernet switch from the rail, do the opposite from the above steps.

## Wall Mounting

Follow the steps below to mount the industrial Ethernet switch using the wall mounting bracket as shown below in Figure 3.4.

Step 1 Remove the DIN-Rail bracket from the industrial Ethernet switch by loosening the screws.

Step 2 Place the wall mounting brackets on the top and bottom of the industrial Ethernet switch.

Step 3 Use the screws to screw the wall mounting bracket on the industrial Ethernet switch.

Step 4 Use the hook holes at the corners of the wall mounting bracket to suspend the 065-7410GPOEP switch on the wall.



Step 5 To remove the wall mount bracket, do the opposite from the steps above.

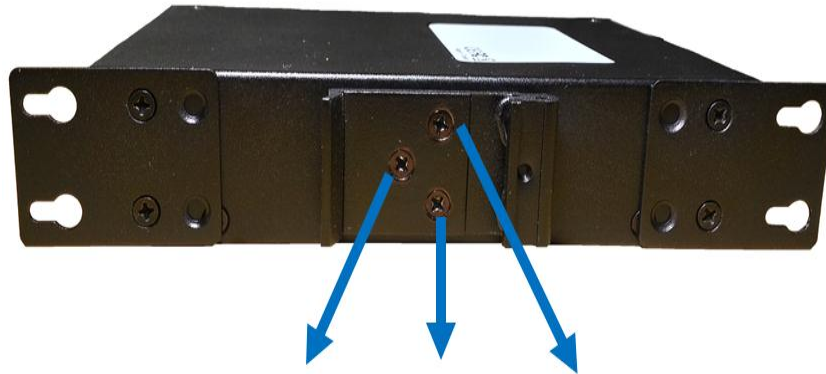

Figure 3.4: Remove DIN-Rail Bracket from the Switch

Below, in Figure 3.5 are the dimensions of the wall mounting bracket.

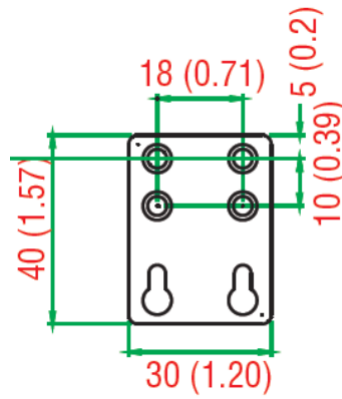

Figure 3.5: Wall Mounting Bracket Dimensions

# Hardware Installation

---

## Installation Steps

This section will explain how to install the Signamax 065-7410GPOEP 10-port industrial PoE+ gigabit unmanaged Ethernet switch.

### Installation Steps

- Step 1 Unpack the 065-7410GPOEP switch from the original packing box.
- Step 2 Check if the DIN-Rail bracket is screwed on the industrial Ethernet switch.
  - If the DIN-Rail is not screwed on the industrial Ethernet switch, please refer to the **DIN-Rail Mounting** section for DIN-Rail installation.
  - If you want to wall mount the industrial Ethernet switch, please refer to the **Wall Mounting** section for wall mounting installation.
- Step 3 To hang the industrial Ethernet switch on a DIN-Rail or wall, please refer to the **Mounting Installation** section.
- Step 4 Power on the industrial Ethernet switch and then the power LED light will turn on.
  - If you need help on how to wire power, please refer to the **Wiring the Power Inputs** section.
  - Please refer to the **LED Indicators** section for LED light indication.
- Step 5 Prepare the twisted-pair, straight-through category 5 cable for Ethernet connection.
- Step 6 Insert one side of the RJ-45 cable into switch's Ethernet port and on the other side into the networking device's Ethernet port, e.g. switch PC or server. The Ethernet port's (RJ-45) LED on the industrial Ethernet switch will turn on when the cable is connected to the networking device.
  - Please refer to the **LED Indicators** section for LED light indication.
- Step 7 When all connections are set and the LED lights all show normal, the installation is complete.

# Trouble Shooting

---

- Verify you have the right power cord or adapter. Never use a power supply or adapter with a non-compliant DC output voltage or it will burn the equipment.
- Select the proper UTP or STP cable in order to construct the network. Use an unshielded twisted-pair (UTP) or shield twisted-pair (STP) cable for RJ-45 connections: 100Ω Category 5e for 10M/100Mbps. Also be sure that the length of any twisted-pair connection does not exceed 100 meters (328 feet).
- Diagnosing LED Indicators: To assist in identifying problems, the switch can be easily monitored with the LED indicators which help to identify if any problems exist.
  - ◆ Please refer to the LED Indicators section for LED light indication.
- If the power indicator LED does not turn on when the power cord is plugged in, the user may have a problem with the power cord. Check for loose power connections, power losses or surges at the power outlet.
  - ◆ Please contact Signamax for technical support service, if the problem still cannot be resolved.
- If the industrial switch LED indicators are normal and the connected cables are correct but the packets still cannot transmit, please check the system's Ethernet devices' configuration or status.

# Technical Specification

Table 7.1 has the technical specifications for the Signamax 065-7410GPOEP switch.

<b>Standard</b>	IEEE 802.3 10BaseT Ethernet IEEE 802.3u 100BaseTX Fast Ethernet IEEE 802.3ab 1000BaseT IEEE 802.3z Gigabit Fiber IEEE 802.3at Power over Ethernet
<b>Protocol</b>	CSMA/CD
<b>Transfer Rate</b>	14,880 pps for Ethernet port 148,800 pps for Fast Ethernet port 1,488,000 pps for Gigabit Ethernet port
<b>Transmission Distance</b>	Up to 100 M (Fast Ethernet)
<b>Transmission Speed</b>	Up to 100 0Mbps
<b>MAC Address</b>	8K Table Size
<b>RJ-45 (Ethernet) Port</b>	8*10/100/1000BaseT/TX (30W/Port), auto negotiation speed, full/half duplex mode, and auto MDI/MDI-X connection
<b>PoE Pin Assignment</b>	RJ-45 port #1 ~ #8 support IEEE 802.3at end-point, alternative A mode. Positive (VCC+): Pin 1, 2 Negative (VCC-): RJ-45 pin 3, 6 Data: Pin 1, 2, 3, 6
<b>SFP Slot</b>	2*SFP slots support dual rate 100/1000Base SFPs
<b>LED</b>	Power Unit: P1 (Green), P2 (Green), fault (Red) Ethernet port: Link/active(Green), 1000 Mbps SFP: Link/active (Green)
<b>Network Cable</b>	10BaseT: 2-pair UTP/STP Cat. 3, 4, 5 cable EIA/TIA-568 100-ohm (100m) 100BaseTX: 2-pair UTP/STP Cat. 5 cable EIA/TIA-568 100-ohm (100m) 1000BaseTX: UTP/STP Cat. 5/5e cable EIA/TIA-568 100-ohm (100m)
<b>Over Current Protection</b>	Single-blow fuse
<b>Power Input</b>	Redundant power DC 48~55V with connective 1*6-pin removable terminal block
<b>Fault Output</b>	1 Relay output
<b>Max Power Consumption</b>	210 Watts @ 48V, 250 Watts @ 51-55V Full load with PoE function
<b>Installation</b>	DIN-Rail mounting, wall mounting (optional)
<b>Operating Temperature</b>	-40° to 167° F (-40°C to 75°C )
<b>Operating Humidity</b>	5% to 95% (Non-Condensing)
<b>Storage Temperature</b>	-40°F ~ 185°F (-40°C to 85°C )
<b>Case Dimension</b>	IP30, metal case 1.81 in. (W) x 3.85 in. (D) x 5.59 in. (H)

	[46mm (W) x 97.8mm (D) x 142mm (H)]
<b>EMI</b>	FCC Class A CE EN61000-4-2/3/4/5/6/8/11/12 CE EN61000-6-2 CE EN61000-6-4
<b>Stability Testing</b>	IEC60068-2-32 (Free fall) IEC60068-2-27 (Shock) IEC60068-2-6 (Vibration)
<b>Safety</b>	UL 508 (Pending)

Table 7.1: 065-7410GPOEP Technical Specification