

# EXTECH<sup>®</sup>

## User Manual

### Power and Harmonics Analyzer Model PQ3350

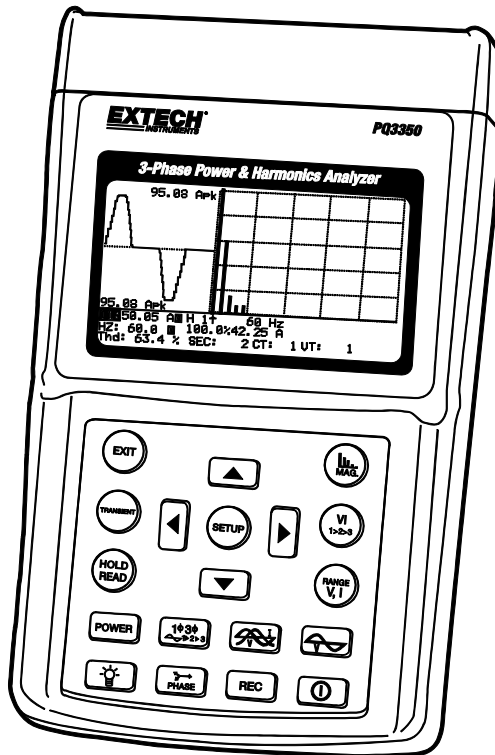

Additional User Manual Translations available at [www.extech.com](http://www.extech.com)



**EN 61010-2-032**  
**CAT III 600V**  
**Pollution Degree 2**

**Definition of Symbols:**



Caution: Refer to Accompanying Documents



Caution: Risk of Electric Shock



Double Insulation

Over-voltage category III (CAT III): equipment in fixed installations.

**WARNING:** If the power analyzer is used in a manner not specified by the manufacturer, the protection provided by the clamp meter may be impaired.



**Please read the following instructions before use**

1. Do not operate this instrument in wet or dusty environments.
2. Do not operate this instrument in the presence of combustible or explosive gas
3. Do not touch exposed metal parts or unused terminals.
4. Consider the use of rubber gloves in operation.
5. Do not operate in excess of AC 500V (Phase to Neutral), or AC 600V (Phase to Phase)
6. Do not operate this instrument if it appears to be malfunctioning



**Do not use the flexible current probe before reading the following instructions.**

1. Do not install the flexible current probe around bare conductors carrying a voltage from 30V to 600V unless you are wearing protective clothing and glove suitable for high-voltage work.
2. Always inspect and check for any damage of the current probe assembly before usage. Do not use the flexible current probe if any damage is found.
3. Do not use the flexible current probe on circuit rated higher than 600V in installation category III.

## Table of Contents

---

<b>PANEL DESCRIPTION</b> .....	<b>5</b>
<b>OPERATING INSTRUCTIONS</b> .....	<b>10</b>
<i>Preparation for use</i> .....	11
<i>Power Quality of a 3 Phase 4 Wire (3P4W) System</i> .....	12
<i>Power Quality of a 3 Phase 3 Wire (3P3W) System</i> .....	13
<i>Power Quality of a Single Phase (1P2W) System</i> .....	14
<i>Power Quality of a 1 Phase 3 Wire (1P3W) System</i> .....	15
<i>Measurement of a System with CT or VT (PT)</i> .....	16
<i>Harmonic Analysis of Voltage or Current</i> .....	17
<i>Display the Phase Angle of Harmonics</i> .....	18
<i>Measurement of Maximum Demand</i> .....	19
<i>Waveform of Voltage and Current</i> .....	19
<i>Waveform for Voltage Only</i> .....	20
<i>Graphic Phase Diagram</i> .....	20
<i>Phase Sequence of a 3 Phase System</i> .....	22
<i>Balanced and Unbalanced 3 Phase (3P3W, 3P4W) Power Source System</i> .....	22
<i>Balanced and Unbalanced 3 Phase (3P3W or 3P4W) Load System</i> .....	23
<i>Transient Capture (Dips, Swells, Outage)</i> .....	24
<i>Down Load Transient Data</i> .....	26
<i>Datalogging Power Data (3P4W, 3P3W, 1P2W, 1P3W)</i> .....	27
<i>Down Load Power Data</i> .....	27
<i>Data Logging Harmonics Data</i> .....	28
<i>Down Load Harmonics Data</i> .....	28
<i>Erase Memory</i> .....	28
<i>HardCopy of SCREEN</i> .....	29
<i>READ the SAVED Data</i> .....	30
<i>Set the CT and VT (PT) Ratio</i> .....	31
<i>Maximum Demand (MD)</i> .....	32
<i>SAMPLE TIME (Data Logging)</i> .....	33
<i>Date and Time</i> .....	34
<b>SPECIFICATIONS</b> .....	<b>35</b>
<b>BATTERY REPLACEMENT</b> .....	<b>44</b>
<b>MAINTENANCE &amp; CLEANING</b> .....	<b>45</b>
<b>Two-year Warranty</b> .....	<b>48</b>

# FEATURES

- Analysis for 3P4W, 3P3W, 1P2W, 1P3W
- True RMS value ( $V_{123}$  and  $I_{123}$ )
- Active Power (W, KW, MW, GW)
- Apparent and Reactive Power (KVA, KVAR)
- Power Factor (PF), Phase Angle ( $\Phi$ )
- Energy (WH, KWH, KVARH, PFH)
- Current measurement from 0.1mA to 3000A, capable of analyzing IT standby power consumption to the maximum demand of a factory
- Display of 35 Parameters in One Screen (3P4W)
- Programmable CT (1 to 600) and PT (1 to 3000) Ratios
- Display of Overlapped Voltage and Current Waveform
- Maximum Demand (MD KW, MW, KVA, MVA) with Programmable Period
- Harmonic Analysis ( $V_{123}$  and  $I_{123}$ ) to the 99<sup>th</sup> Order
- Display of 50 Harmonics in one Screen with Waveform
- Display of Waveform with Peak Values (1024 Samples / Period)
- Analysis of Total Harmonic Distortion (THD-F)
- Graphic Phase Diagram with 3 Phase System Parameters
- Capture 28 Transient Events (Time + Cycles) with Programmable Threshold (%)
- DIP, SWELL, and OUTAGE are included in transient events.
- 3 Phase Voltage or Current Unbalanced Ratio (VUR, IUR)
- 3 Phase Voltage or Current Unbalanced Factor (d0%, d2%)
- Calculated Unbalanced Current through Neutral Line (In)
- 512K Memory with Programmable Interval (Sampling time from 2 to 6000 seconds, data logging time from 4.7 hours to 1180 days for 3P4W system)
- Output of Waveform, Power Parameters and Harmonics on Command
- Large Dot Matrix LCD Display with Backlight
- Optical Isolated RS-232C Interface

# PANEL DESCRIPTION

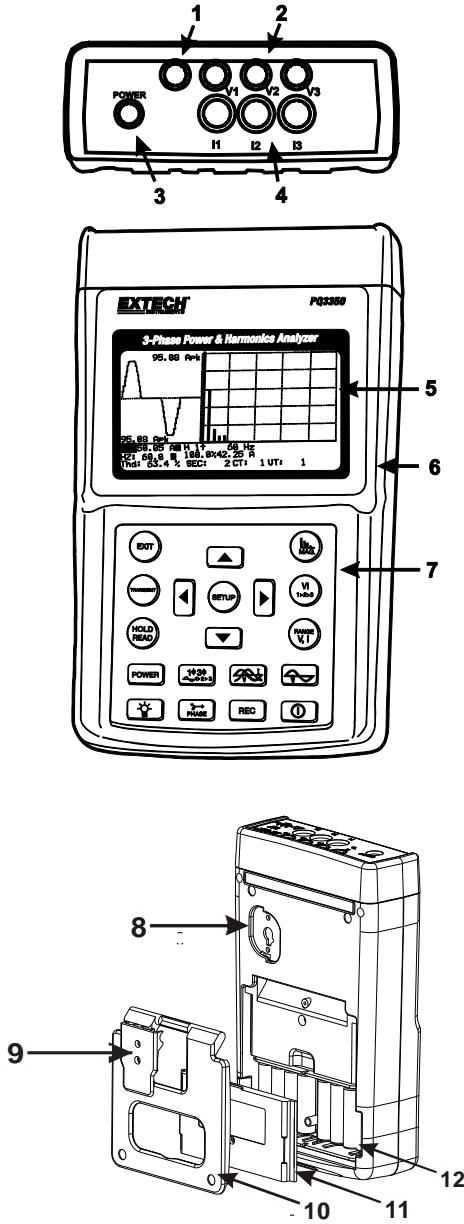

## Panel Description

1. Input Terminal for Neutral Line (Voltage)
2. Voltage Input Terminals for Each Phase (V1, V2, V3)
3. External DC Input (The AC adaptor must be 600V isolated)
4. Current Input Terminals for Each Phase (I1, I2, I3)
5. LCD Display
6. Indication of locations where SEC., CT, VT, and SETUP are displayed in LCD.
7. Buttons
8. RS-232C Window
9. Stand Holder
10. Stand
11. Battery Cover
12. Battery Compartment

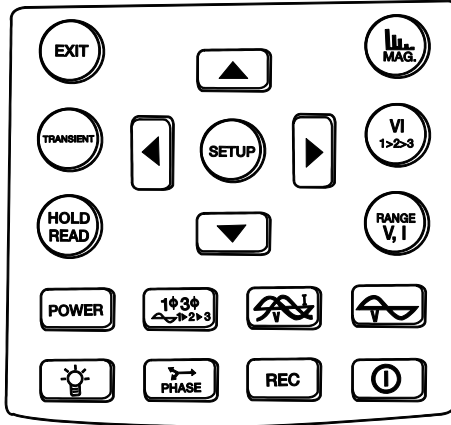

Press this button to exit the SETUP menu and to exit transient detection mode



Press this button to perform transient detection



Press this button to hold the data displayed in LCD, press again to continue operation.



Press this button to begin the measurement of Harmonics in magnitude.



Press this button to select V1, I1, V2, I2, V3, or I3 for Harmonics analysis



Press this button for the voltage or current input range (Harmonics)



Press to enter the Main Setup Menu (also used to navigate menu items).



Press this button to increment value by one. Hold the button for two seconds or more to speed up the increment.



Press this button to decrement a value by one.

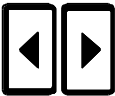

In harmonic analysis mode, use these buttons to move the cursor left or right.



Press this button to start data logging. Press it again to stop data logging. The sampling interval is displayed in the LCD via the SEC indicator.



In the power mode, press this button to display the phase. In the harmonic analysis mode, press this button to display phase angle instead of magnitude. Press to initiate Transient detection mode.



Press this button to turn the back light on. Press it again to turn the back light off.



Press this button to begin measuring power.



Press this button to display the waveforms for voltage and current.



Press this button to display the waveform for voltage only



In the power mode, press this button to select the appropriate system (3P4W, 3P3W, 1P2W or 1P3W). In the waveform mode, press to select (V1, I1), (V2, I2), or (V3, I3).



Press this button to turn the power on or off.

## Current Probe (100A)

**WARNING:** All the current probes connected to the power analyzer must be of the same model and same range. Mixed models and different ranges selected will cause incorrect result of measurement.

1. Jaw Assembly
2. Trigger
3. Range Selector
4. 6 pin mini DIN connector

```
Down Load File: 1:19
REC DATE: 5- 7-22 10:14:50
HZ: 50
UT: 1
CT: 1
SEC: 2
CLAMP: 100
MD TIME: 15
TRANS REF:110.0 U
SDUP: 5%

Year Month Date Hour Minute Second
2005 7 22 13 22 42
```

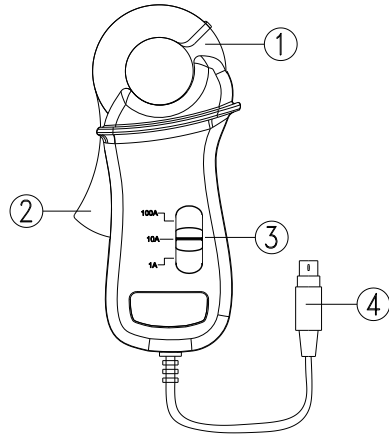

NOTE: To choose the 100A current probe, press the **SETUP** button to select CLAMP. When the CLAMP is reverse video, press the ▲ or ▼ button to select 100.

## Current Probe (1000A)

1. Jaw Assembly
2. Trigger
3. Range Selector
4. 6 pin mini DIN connector

```
Down Load File: 1:19
REC DATE: 5- 7-22 10:14:50
HZ: 50
UT: 1
CT: 1
SEC: 2
CLAMP: 1000
MD TIME: 15
TRANS REF:110.0 U
SDUP: 5%

Year Month Date Hour Minute Second
2005 7 22 13 21 16
```

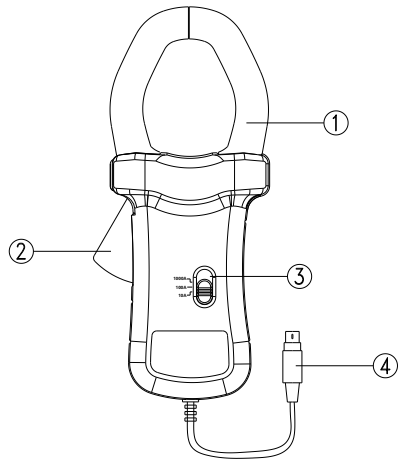

NOTE: To select the 1000A current probe, press the **SETUP** button to select CLAMP. When the CLAMP is reverse video, press the ▲ or ▼ button to select 1000.



## Flexible Current Probe (3000A or 1200A)

1. Control Box
2. Output Range Select Switch
3. Flexible Loop
4. Coupling Assembly

```
Down Load File: 1:19
REC DATE: 5- 7-22 10:14:50
HZ: 50
VT: 1
CT: 1
SEC: 2
CLAMP: 3000
MD TIME: 15
TRANS REF:110.0 V
SDUP: 5%

Year  Month  Date  Hour  Minute  Second
2005   7     22   13    22     42
```

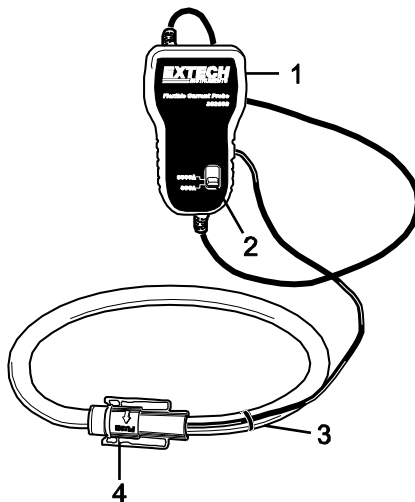

**NOTE:** To select the 3000A flexible current probe, press the SETUP button to select CLAMP. When the CLAMP is reverse video, press the ▲ or ▼ button to select 3000.

**NOTE:** To select the 1200A flexible current probe, press the SETUP button to select CLAMP. When the CLAMP is reverse video, press the ▲ or ▼ button to select 1200.

**WARNING:** All the current probes connected to the power analyzer must be of the same model and same range. Mixed models and different ranges will yield incorrect measurement results.

# OPERATING INSTRUCTIONS

**NOTE:** Pay special attention to the flexible current probe connections.

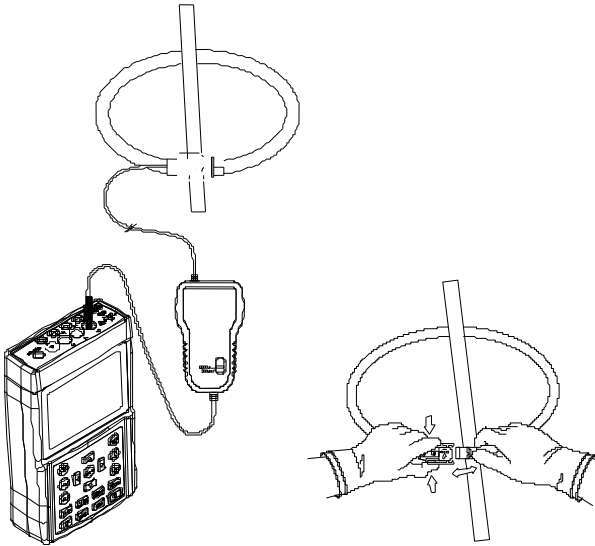

1. Connect the flexible probe around the conductor.
2. Make sure the current flowing direction is consistent with the arrow marked on the probe coupling. If the flexible current probe is connected in the right orientation, the correct phase will be displayed in the oscilloscope.
3. Place the probe coupling more than 25mm away from the conductor.

**WARNING:** Always wear appropriate gloves in operation.

**NOTE:** Select the correct CLAMP in the SETUP menu. When the current probe is connected to the power analyzer, the power analyzer will automatically detect the range selected.

**NOTE:** Select the correct frequency (Hz) in the SETUP menu.

## Preparation for use

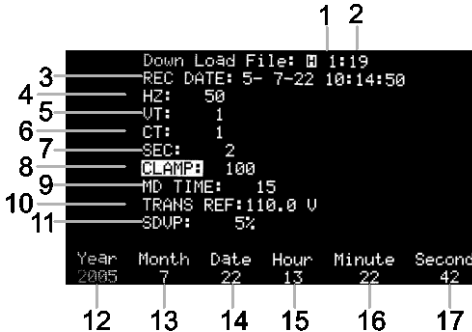

- a. Press **SETUP** button to enter setup screen. Press **SETUP** again to select the item for setting (the selected item will be displayed in reverse video).

After selecting the item, press **▲** or **▼** buttons to set up its value.

- b. After finishing setting up, press **EXIT** button to leave setup mode.

1. Select the data for download (the data in order is 0~84)

**P** means power data.

**H** means harmonics data.

**H** in reverse video means Hardcopy screen data (See Hardcopy section for examples)

(to view the Hardcopy data, press the **HOLD** button. Press **HOLD** button again to exit).

2. Shows the total logged data in the analyzer: max. 85 logging data.
3. **REC DATE**: shows the starting logging time of the 1<sup>st</sup> downloaded file.
4. **HZ**: set up the frequency (50, 60 or AUTO) of the system.
5. **PT**: set up PT value.
6. **CT**: set up CT value.
7. **SEC**: set up the interval seconds of logged data. (2 to 6000 seconds)
8. **CLAMP**: set up the clamps selected (100A, 1000A or 3000A).
9. **MD TIME**: set up the time of Maximum Demand (1~60 minutes).
10. **TRANS REF**: set up the transient voltage (which will be automatically changed in accordance with PT).
11. **SDVP**: set up upper and lower limits % of transient voltage detection.
12. **YEAR**: Set up "year" of calendar clock.
13. **MONTH**: Set up "month" of calendar clock.
14. **DATE**: Set up "date" of calendar clock.
15. **HOUR**: Set up "hour" of calendar clock.
16. **MINUTE**: Set up "minute" of calendar clock.
17. **SECOND**: Second can be displayed only (it cannot be adjusted).
18. **Clear all data memory from the unit**: Hold the REC button and turn the power on.

## Power Quality of a 3 Phase 4 Wire (3P4W) System

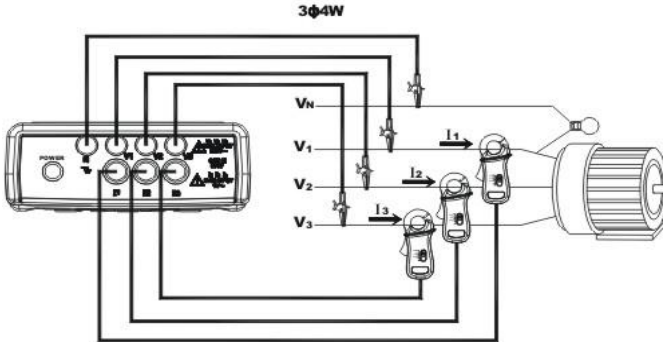

- Turn the power on. Press the **POWER** and the **1Φ3Φ** buttons to select the 3P4W system. The type of system will be displayed at the left bottom corner in the LCD.
- Connect the four test leads to the voltage terminals V1, V2, V3 and the VN (Neutral) of the system.
- Connect the test leads to L1, L2, and L3 of the 3P4W system.
- Connect the three current probes to the power analyzer input terminal I1, I2, and I3.
- Clamp on to the L1, L2, and L3 of the 3P4W system. Make sure the current flows from the front of the current probe to the back.
- All of the system parameters will be shown in the LCD

<b>U12</b> 381.6 V	<b>U13</b> 219.9 V	<b>I1</b> 799.1 mA
<b>U23</b> 381.1 V	<b>U21</b> 219.9 V	<b>I2</b> 800.1 mA
<b>U31</b> 379.1 V	<b>U32</b> 219.5 V	<b>I3</b> 800.7 mA
<b>P1</b> 156.5 W	<b>S1</b> 175.7 VA	<b>Q1</b> - 79.8 VAR
<b>P2</b> 154.0 W	<b>S2</b> 175.9 VA	<b>Q2</b> - 84.9 VAR
<b>P3</b> 153.8 W	<b>S3</b> 175.7 VA	<b>Q3</b> - 84.9 VAR
<b>PΣ</b> 464.4 W	<b>SΣ</b> 527.1 VA	<b>QΣ</b> -249.4 VAR
PF2: 0.88	PF1: 0.89	PF2: 0.87
PF3: 0.87	PFH: 0.88	φ1: - 26.9°
φ2: - 29.0°	φ3: - 29.0°	
<b>WH</b> 127.7 WH	<b>SH</b> 144.8 VAH	<b>QH</b> 68.2 VARH
H2: 50.0	<b>MD</b> 436.5 VA	<b>MDΣ</b> 385.1 W -15
3φ4W	<b>SEC:</b> 2	<b>CT:</b> 1
	<b>VT:</b> 1	

For a description of each parameter, refer to section XIV. NOMENCLATURE.

## Power Quality of a 3 Phase 3 Wire (3P3W) System

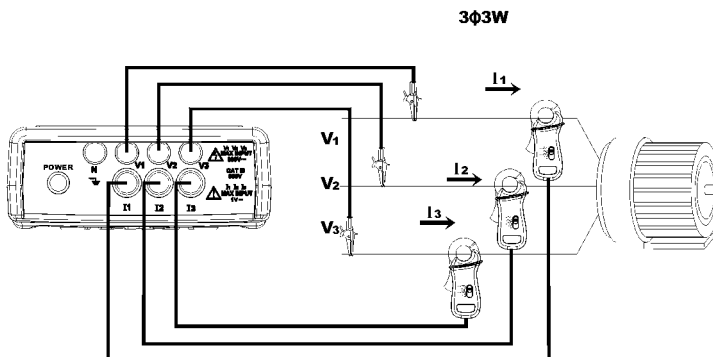

- Turn the power on. Press the **POWER** and the **1Φ3Φ** buttons to select the 3P3W system. The type of system will be displayed at the bottom right of the LCD.
- Connect the four test leads to the voltage terminals L1, L2, and L3 of the system.
- Connect the three current probes to the power analyzer input terminal I1, I2, and I3.
- Clamp on to the L1, L2, and L3. Make sure the current flows from the front of the current probe to the back.
- All parameters of the system will be shown in the LCD

<b>U12:</b> 381.1 V	<b>I1:</b> 799.2mA	
<b>U23:</b> 381.4 V	<b>I2:</b> 800.6mA	
<b>U31:</b> 379.6 V	<b>I3:</b> 801.0mA	
<b>P2:</b> 464.6 W	<b>S2:</b> 527.4 VA	<b>Q2:</b> -249.7 VAR
PF2: 0.88		
PFH: 0.88		
WH: 9.8 WH	SH: 11.1 VAH	QH: 5.2 VARH
HZ: 50.0 Hz	MD: VA	MD: W -15
3Φ3W	SEC: 2	CT: 1
	UT: 1	

For a description of each parameter, refer to XIV. NOMENCLATURE.

## Power Quality of a Single Phase (1P2W) System

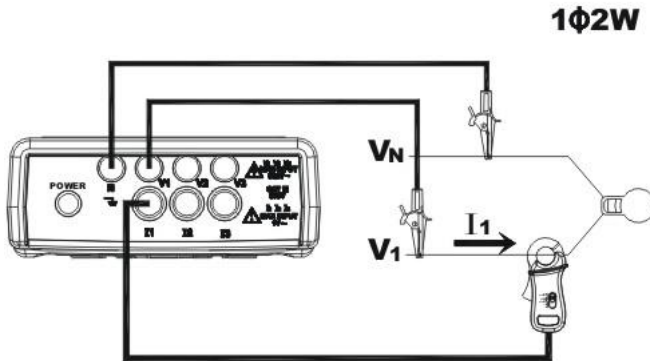

- Press **POWER** and then **1Φ3Φ** to select the 1P2W system. The type of system will be displayed at the bottom right of the LCD
- Connect the test leads to the voltage terminals L1 and V<sub>N</sub> (Neutral) of the system.
- Connect one current probe to the power analyzer input terminal I1.
- Clamp on to the L1. Make sure the current flows from the front of the current probe to the back (see arrow labeled on clamp probe).
- All of the parameters of the system will be shown in the LCD



For a description of each parameter, refer to XIV. NOMENCLATURE.

## Power Quality of a 1 Phase 3 Wire (1P3W) System

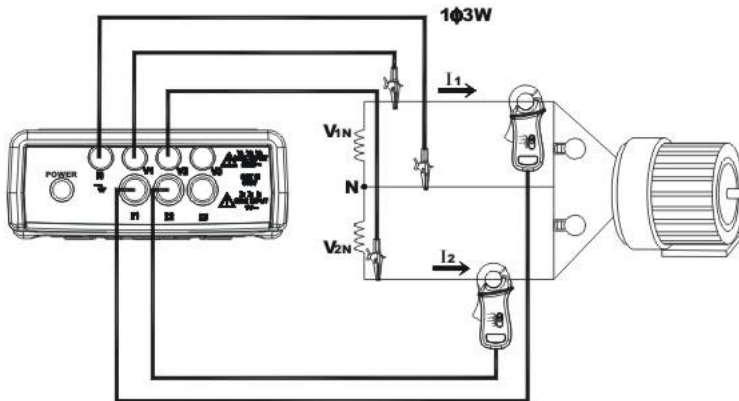

- Turn the power on. Press the **POWER** and the **1Φ3Φ** buttons to select the 1P3W system. The type of system will be displayed at the bottom right of the LCD.
- Connect the test leads to the voltage terminals L1, L2 and V<sub>N</sub> (Neutral) of the system.
- Connect the two current probes to the power analyzer input terminal I1 and I2.
- Clamp on to the L1 and L2. Make sure the current flows from the front of the current probe to the back.
- All of the system parameters will be shown in the LCD

U1: 220.0 V	I1: 797.7 mA	
U2: 220.0 V	I2: 800.7 mA	
P1: 156.4 W	S1: 175.4 VA	Q1: -79.3 VAR
P2: 154.2 W	S2: 176.1 VA	Q2: -85.0 VAR
PΣ: 310.6 W	SΣ: 351.3 VA	QΣ: -164.3 VAR
PF2: 0.88	PF1: 0.89	PF2: 0.87
PFH: 0.88	φ1: -27.1°	φ2: -29.0°
WH: 4.3 WH	SH: 4.8 VAH	QH: 2.2 VARH
fz: 50.0 Hz	MD: VA	MD: W -15
1Φ3Φ	SEC: 2 CT	1 UT: 1

For a description of each parameter, refer to NOMENCLATURE section

## Measurement of a System with CT or VT (PT)

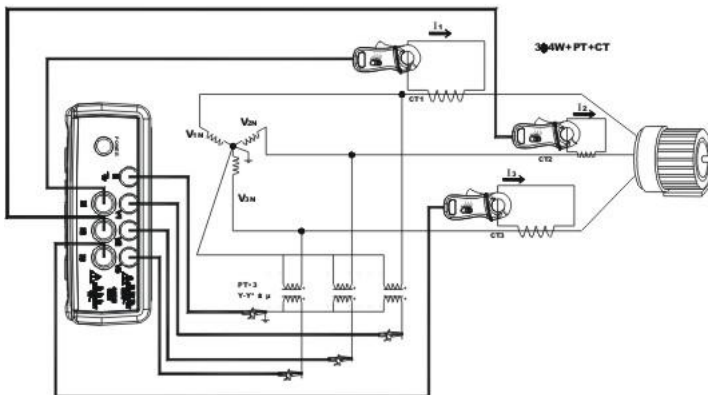

- Turn the power on. Press the POWER and the **1Φ3Φ** buttons to select the 3P4W system. The type of system will be displayed at the bottom right of the LCD.
- Connect the four test leads to the secondary voltage terminals L1, L2, L3 and the  $V_N$  (Neutral) of the system.
- Clamp on to the secondary coils of L1, L2, and L3. Make sure the current flows from the front of the current probe to the back (see the arrow label on the clamp probe).

```

Down Load File: 1:19
REC DATE: 5- 7-22 10:14:50
HZ: 50
VT: 1
CT: 1
SEC: 2
CLAMP: 100
MD TIME: 15
TRANS REF:110.0 V
SDVP: 5%

Year Month Date Hour Minute Second
2005 7 22 13 22 20
    
```

- Press **SETUP** to enter the SETUP menu.
- Press **SETUP** several times until the CT symbol is highlighted.
- Press the **▲** or **▼** button to increment or decrement the RATIO specified by the CT.



```

Down Load File: 0 1:19
REC DATE: 5- 7-22 10:14:50
HZ: 50
UT: 1
CT: 1
SEC: 2
CLAMP: 100
MD TIME: 15
TRANS REF:110.0 V
SDUP: 5%

Year Month Date Hour Minute Second
2005 7 22 13 22 9

```

- g. Press the **SETUP** button several times until the VT symbol is highlighted.
- h. Press the **▲** or **▼** button to increment or decrement the RATIO specified by the VT.
- i. All 35 system parameters will be shown in the LCD

For a description of each parameter, refer to NOMENCLATURE section.

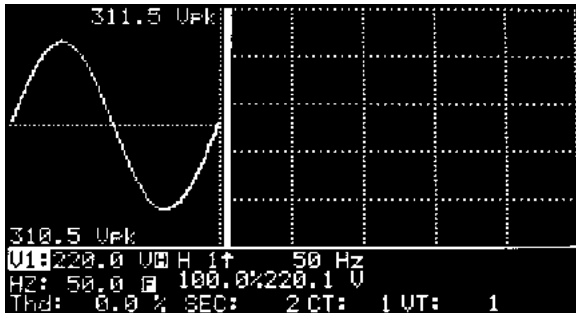

## Harmonic Analysis of Voltage or Current

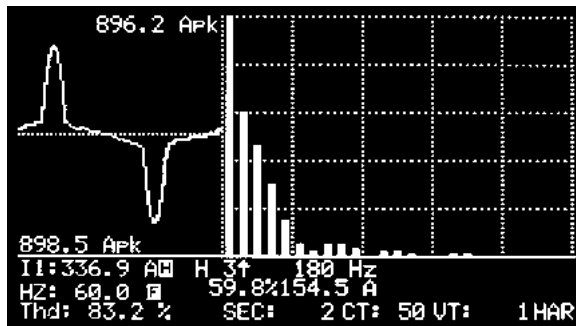

(Normal Voltage without Distortion and Harmonics)





## (Distorted Current with Harmonics)

- a. Setup the analyzer for measurement of any power system (3P4W, 3P3W, 1P2W, or 1P3W). To view the harmonic analysis of voltage or current, press the  button.
- b. Once the  button is pressed, the waveform will be shown in the left-hand portion of the LCD, and the 1<sup>st</sup> to 50<sup>th</sup> order harmonics will be shown in the right-hand portion of the LCD.
- c. The positive and negative peak values will be shown in the waveform (Vpk).
- d. The true RMS value & total harmonic distortion of voltage or current is shown under the waveform.
- e. The cursor ( $\uparrow$  arrow) will point to the current order of harmonics. The frequency (HZ) will be displayed next to the cursor. The percentage of harmonics (%) will be displayed below the cursor. The magnitude of the harmonics (V or A) or phase angle will be displayed next to the %.
- f. Press the VI button to change to the various inputs (V1, I1, V2, I2, V3, I3)
- g. If the wave form is too small or clipped, press the RANGE button to change ranges.
- h. To move the cursor to the next harmonic, use the  $\blacktriangleleft$  or  $\blacktriangleright$  button.
- i. To see the next page (51<sup>st</sup> to 99<sup>th</sup> order) press the  $\blacktriangleright$  button to pass the 50<sup>th</sup> order or press the  $\blacktriangleleft$  button to pass the 1<sup>st</sup> order.

NOTE: If the waveform is clipped at the peak or too small in the LCD, press the RANGE button to select HIGH or LOW range for a better display. The range indicator is the symbol after the unit of RMS value, L or H.

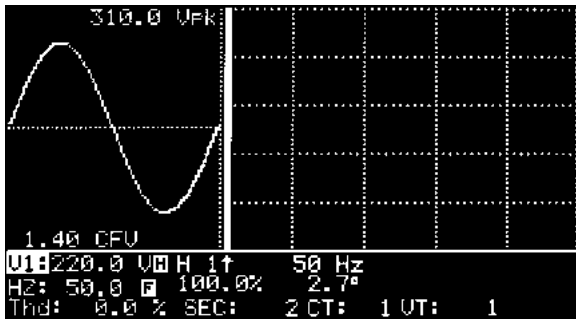
## Display the Phase Angle of Harmonics



When the  button is pressed the magnitude of each harmonic is displayed. To review the phase angle of each harmonic, press the PHASE button. The phase angle will be displayed next to the % display icon. V1 does not trigger at exactly 0 degrees; it may be a few degrees after '0'. The remaining signals (V2, V3, I1, I2, I3) are sampled when V1 is triggered. In other words, the phase angles for V2, V3, I1, I2, and I3 are sampled with respect to V1. For example, if V1, I1 have a phase difference of 30 degrees, they are displayed as V1 (2 degrees), I1 (32 degrees) in the harmonics analysis.

NOTE: If the waveform is clipped at the peak or too small in the LCD, press the RANGE button to select HIGH or LOW range for a better display. The range indicator is the symbol after the unit of RMS value, L or H.

## Measurement of Maximum Demand

1. Set the time interval for maximum demand (refer to page 31)
2. The analyzer will integrate the KW and KVA over the specified interval.
3. The maximum demand (MD) updates if new demand is greater than the previous value.

In the following example, the maximum demand is 527.4VA and 527.4W. The time interval for maximum demand is 2 minutes.

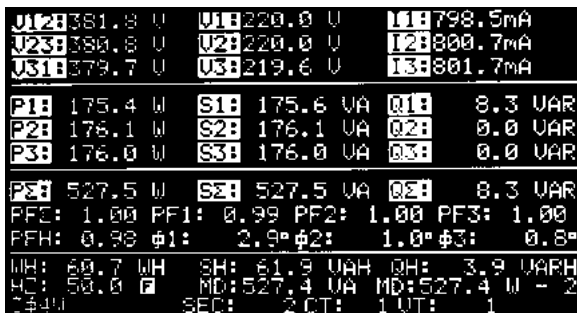

## Waveform of Voltage and Current

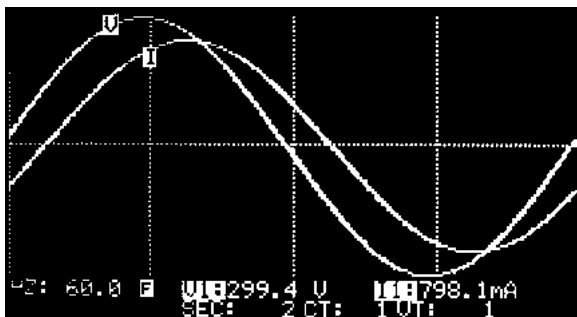

Press this button to display the waveforms for voltage and current simultaneously.

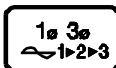

Press this to select different inputs (V1, I1), (V2, I2), or (V3, I3).

NOTE: The triggering point is the zero crossing point of V1 for V2, V3, I2, and I3. The triggering point for I1 is its own zero crossing point in case V1 is not present.

NOTE: In the waveform display mode, one period/cycle of 1024 data points is displayed.

## Waveform for Voltage Only

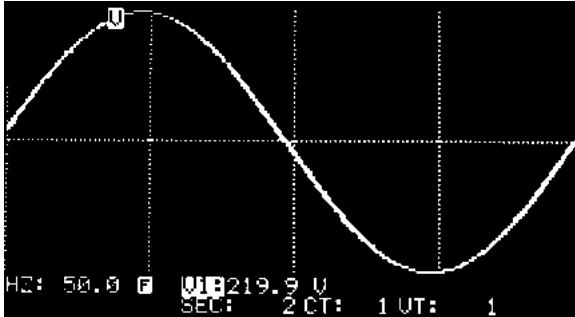

Press this button to display the voltage waveform only. The true RMS value of voltage will be displayed at the bottom of the LCD.

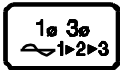

Press this button to select V1, V2, or V3.

NOTE: The triggering point is the zero crossing point of V1 for V2 and V3.

NOTE: In the waveform mode, one period/cycle of 1024 data points is displayed.

## Graphic Phase Diagram

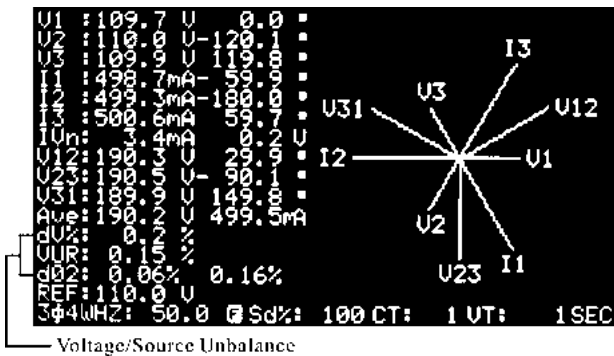

Press this button to display the phase diagram.

The voltage and current signals are displayed in phase format (magnitude, angle).

V1 is the reference. The V1 angle is always 0 degrees.

The phase angles of V2, V3, I1, I2, and I3 are displayed with respect to V1.

V1, V2, V3, I1, I2, I3, V12, V23, and V31 are displayed in vector form graphically.

V1, V2, V3: Phase voltages in phase format with respect to V1

I1, I2, I3: Line currents in phase format with respect to V1.

IVn: Calculated voltage and current of the neutral with respect to ground.

V12, V23, V31: Line voltage in phase format with respect to V1.

Ave: Average of line voltage V12, V23, and V31 and line current I1, I2, and I3

dV%: Historical maximum % value of  $(\text{Max}(V1, V2, V3) - \text{Min}(V1, V2, V3)) / \text{Min}(V1, V2, V3) * 100\%$

VUR: Voltage (Unbalanced Ratio)

d02: The first number is Zero Sequence Unbalanced Ratio in % (d0) of voltage; the second number is the Negative Sequence Unbalanced Ratio in % (d2) of voltage. When VUR is displayed before d02, d02 represents the Zero and Negative Sequence Unbalanced Ratios for voltage.

REF: nominal voltage for transient detection reference

Sd%: threshold in % for transient detection with respect to nominal voltage (REF).

NOTE: The phase is drawn only when the reading exceeds 200 counts. If V is zero, the phase of the current will not be drawn.



Press this button to change the display from VUR to IUR

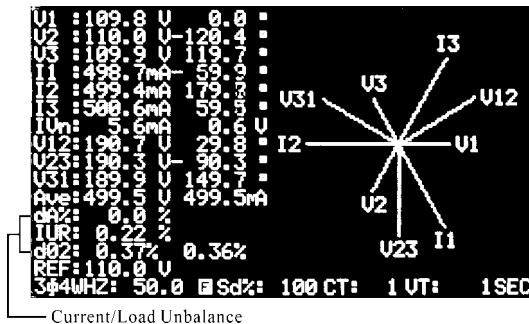

dA%: Historical max % value of  $(\text{Max}(I1, I2, I3) - \text{Min}(I1, I2, I3)) / \text{Min}(I1, I2, I3) * 100\%$

IUR: Current Unbalance Ratio

d02: The first number is Zero Sequence Unbalanced Ratio in % (d0) for current; the second number is the Negative Sequence Unbalanced Ratio in % (d2) for current. When IUR is displayed before d02, d02 represents the Zero (d0) and Negative (d2) Sequence Unbalanced Ratios for current.

REF: Nominal voltage for transient detection reference

Sd%: Threshold in % for transient detection with respect to nominal voltage (REF).

NOTE: If the voltage of L1, L2, and L3 is not connected in the correct sequence, the analyzer will show L1-3-2 in the right top corner, and it will beep to warn of an incorrect phase sequence.

### Phase Sequence of a 3 Phase System

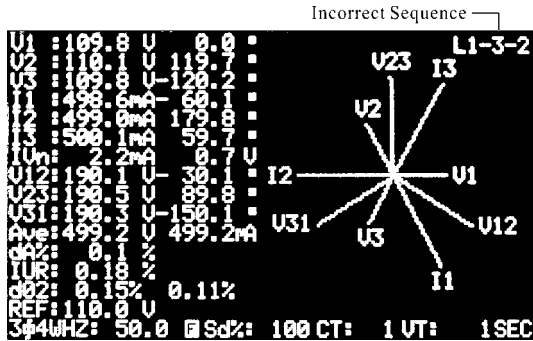

Press this button to display the phase diagram.

In this mode, the analyzer also detects the phase sequence. If the voltage of L1, L2, and L3 is not connected in the correct sequence, the analyzer will show L1-3-2 in the right top corner, and it will beep to warn of an incorrect phase sequence.

### Balanced and Unbalanced 3 Phase (3P3W, 3P4W) Power Source System

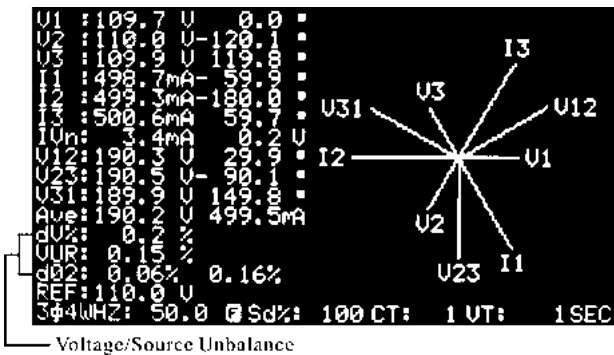

In order to check if a system is balanced, press this button to display the phase diagram along with the VUR.

### Balanced System

If a 3 phase power source system is balanced, the parameters should be as follows:

$$V1 = V2 = V3$$

$$V12 = V23 = V31$$

The phase angle of V2 = -120; the phase angle of V3 = 120

Vn (voltage of neutral with respect to ground) = 0V

VUR = 0%

d0% = 0%

d2% = 0%

### Unbalanced Systems

If the values differ from the numbers above, an unbalanced power source system may be the reason. The magnitude of the differences can be used as an indication of an unbalanced power source system. The larger the difference, the further unbalanced the system will be.

### Balanced and Unbalanced 3 Phase (3P3W or 3P4W) Load System

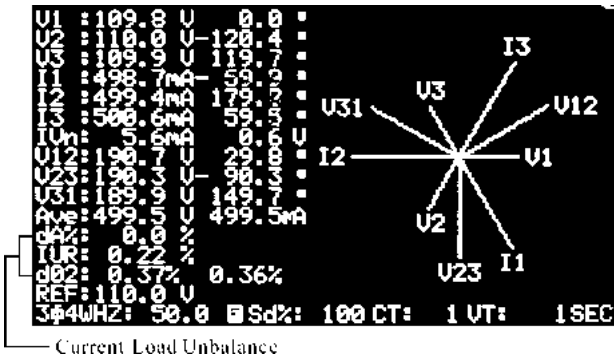

In order to check if current of a system is balanced, press the button twice to display the phase diagram with the IUR displayed.

### Balanced System

If a 3 phase load system is balanced, the parameters should be as follows:

$$I1 = I2 = I3$$

The phase angle for I2 and I1 ( $I2 \pm I1$ ) =  $\pm 120$

The phase angles of I3 and I2 ( $I3 \pm I2$ ) =  $\pm 120$

In (current of neutral) = 0A

IUR = 0%

d0% = 0%

d2% = 0%

### Unbalanced Systems

If the values differ from the numbers above, an unbalanced load system may be the reason. The magnitude of the difference can be used as an indication of an unbalanced power source system. The larger the difference, the more unbalanced the load will be.

## Transient Capture (Dips, Swells, Outage)

1. Press the **SETUP** button to enter Setup mode.
2. Press the **SETUP** button until Hz is highlight. Set the Hz to the actual Line frequency and not to AUTO.
3. Press the **SETUP** button until TRANS REF is highlighted.

```
Down Load File: 1:19
REC DATE: 5- 7-22 10:14:50
HZ: 50
UT: 1
CT: 1
SEC: 2
CLAMP: 100
MD TIME: 15
TRANS REF:110.0 U
SDVP: 5%

Year Month Date Hour Minute Second
2005 7 22 13 23 10
```

```
Down Load File: 1:19
REC DATE: 5- 7-22 10:14:50
HZ: 50
UT: 1
CT: 1
SEC: 2
CLAMP: 100
MD TIME: 15
TRANS REF:110.0 U
SDVP: 5%

Year Month Date Hour Minute Second
2005 7 22 13 23 5
```

4. Press the **▲** or **▼** button to increment or decrement the nominal voltage for a reference. This should be the phase to phase or phase to neutral voltage, depending on the type of circuit being tested.
5. Press the **SETUP** button until SDVP is highlighted.
6. Press the **▲** or **▼** button to increment or decrement the threshold in % (SDVP). A typical setting for SDVP is 5%.
7. Press the **EXIT** button to exit Setup mode.
8. Press the PHASE button once.
9. Press the **TRANSIENT** button to start the "Transient Capture"
10. If the analyzer captures any transient events (DIP, SWELL, or OUTAGE), the backlight will switch on.
11. Press the **TRANSIENT** button to review the recorded TRANSIENT events.
12. Press the **TRANSIENT** button again to resume capturing transient events.
13. To exit TRANSIENT CAPTURE mode, press the **EXIT** button.



**Definition of SWELL, DIP, and OUTAGE:**

**SWELL:**  $V_{RMS} > [V_{REF} + (V_{REF} * SD\%)]$

Code for SWELL: 1

If the true RMS value of either phase (V1, V2, or V3) rises above the nominal value plus the threshold (REF + SD%), it is regarded as SWELL. Code for SWELL is 1.

**DIP:**  $V_{RMS} < [V_{REF} - (V_{REF} * SD\%)]$

Code for DIP: 2

If the true RMS value of either phase (V1, V2, or V3) falls below the nominal value plus the threshold, it is regarded as DIP. The code for DIP is 2.

**OUTAGE:**  $V_{RMS} < 30 \text{ to } 40V$

Code for OUTAGE: 4

If the true RMS value of either phase is less than 30 to 40V, it is regarded as OUTAGE. The code for OUTAGE is 4.

Transient Code Table:

	SWELL	DIP	OUTAGE	COMMENT
CODE	1	2	4	Codes can be added together

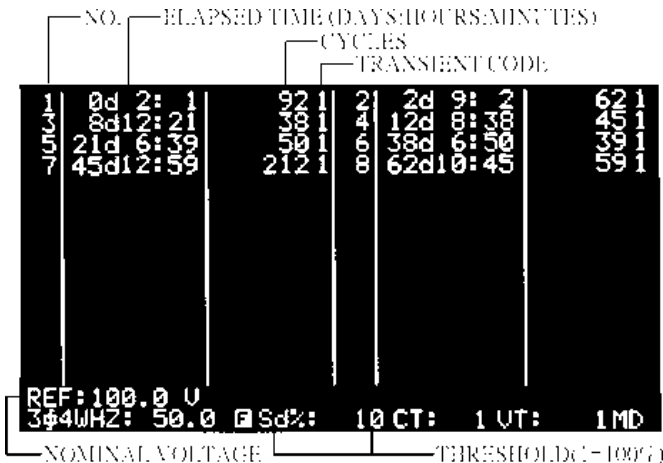

**DISPLAY FORMAT:**

First column: Sequential number of events.

Second column: Elapsed time (the elapsed time format is DAYS, HOURS, MINUTES) 99 days 24 hours 60 minutes max

The third column: Number of cycles that the event was recorded.

The fourth column: Code of transient events. There can be more than one transient condition occurring in one event.

NOTE: In the TRANSIENT CAPTURE mode, the analyzer takes 128 samples of each cycle for each phase continuously.

NOTE: When the user presses the TRANSIENT button to review the recorded events, the capture operation is paused until TRANSIENT is pressed again. The timer is also stopped when TRANSIENT is pressed. Therefore,

the time stamp is not correct when the user presses the TRANSIENT button to resume operation.

NOTE: The analyzer can record up to 28 events. When the analyzer has recorded 28 events, it stops the capture operation, turns the backlight on, and displays the 28 transient events.

NOTE: The codes can be summed to indicate two or three conditions. For example, if the code is 6, DIP and OUTAGE (2+4) have been added.

NOTE: The longest duration for a capture operation is 99 days. Use the external DC power adaptor for long capture operation.

WARNING: Select 50 or 60 Hz for transient capture. If AUTO is selected for frequency, the unit will not allow entrance to the TRANSIENT capture mode (an audible beep will sound).

## Down Load Transient Data

When the **TRANSIENT** button is pressed to display CAPTURED EVENTS, the data is also output through the RS-232 interface simultaneously.

The data output is in the same format as the LCD display format (ASCII)

YEAR MONTH DAY HOUR MINUTE SECOND CT REF CODE

01 ELAPSED\_TIME CYCLES CODE

02 ELAPSED\_TIME CYCLES CODE

03 ELAPSED\_TIME CYCLES CODE

04 ELAPSED\_TIME CYCLES CODE

See the PQ3350 Software Help manual on how to download the Transient data from the meter.

## PC Software

This meter has the capability to connect to and communicate with a PC.

Check the software download page of the website [www.extech.com/software/downloads](http://www.extech.com/software/downloads) for the latest version of the PC software and its operating system compatibility.

Download and unzip the software. Run ExtechInstaller.exe and then refer to the instructions provided in the HELP Utility within the software program.

## Datalogging Power Data (3P4W, 3P3W, 1P2W, 1P3W)

1. Set the datalogger sampling time (rate)
2. Press the **POWER** button to enter the power measurement mode.
3. Press the **1Φ3Φ** button to select the appropriate system (3P4W, 3P3W, 1P3W, or 1P2W).
4. Press the **REC** button to start logging. A **REC** symbol will display.
5. To stop logging, press the **REC** button again.



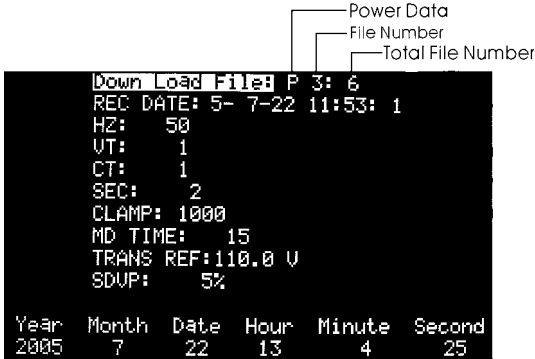

## Down Load Power Data



1. Press the **SETUP** button.
2. "Down Load File" will be shown in reverse video.
3. Press the **▲** or **▼** button to select the file number.
4. If the data stored in a selected file is power data, a leading symbol "P" will precede the file name
5. Press the EXIT button.
6. When a CTRL D command is received through the RS-232C port, it downloads stored power data.

**NOTE:** In the setup mode, the unit will not accept commands through the RS-232C port. To down load data, press the EXIT button to return to normal measurement mode.



## Data Logging Harmonics Data

1. Set the sampling time (rate) for data logging
2. Press the  button to enter the harmonics measurement mode.
3. Press the  button to select the desired input (V1, I1, V2, I2, V3, or I3).
4. Press the  button to start data logging. A REC symbol will be displayed at the bottom of the LCD.
5. To stop data logging, press the  button again.

**WARNING:** If there is no input at V1, the sampling rate could be longer than the programmed value.

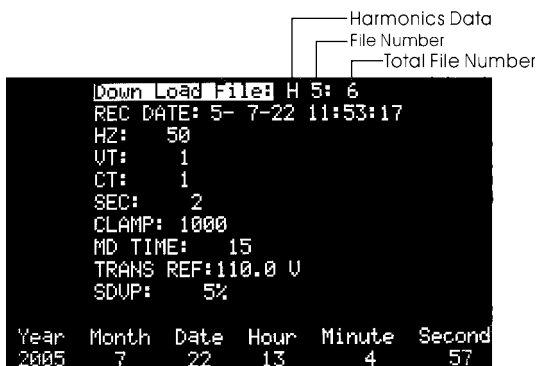
## Down Load Harmonics Data



1. Press the  button.
2. "Down Load File" will be shown in reverse video.
3. Press the  or  button to select the file number.
4. If the data stored in a selected file is harmonics data, a leading symbol "H" will precede the file name.
5. Press the EXIT button.
6. When the unit receives a CTRL D command through the RS-232C port, it will down load previously saved harmonic data.

**NOTE:** In the setup mode, the unit will not accept any commands through the RS-232C port. To down load data, press the EXIT button to return to normal measurement mode.

## Erase Memory

Turn off the unit and then HOLD the REC button and then press the Power button to turn on the meter. Release the power button and then release the REC button.

## HardCopy of SCREEN

U12:	0.0 U	U1:	0.0 U	I1:	0.0 A				
U23:	0.0 U	U2:	0.0 U	I2:	0.0 A				
U31:	0.0 U	U3:	0.0 U	I3:	0.0 A				
P1:	0.0KW	S1:	0.0KVA	Q1:	0.0KVAR				
P2:	0.0KW	S2:	0.0KVA	Q2:	0.0KVAR				
P3:	0.0KW	S3:	0.0KVA	Q3:	0.0KVAR				
PΣ:	0.0KW	SΣ:	0.0KVA	QΣ:	0.0KVAR				
PFE:	0.00	PF1:	0.00	PF2:	0.00	PF3:	0.00		
PFH:	0.00	φ1:	0.0°	φ2:	0.0°	φ3:	0.0°		
WH:	0.0KWH	SH:	0.0KVAH	QH:	0.0KVAH				
HZ:	50.0	MD:	W	MD:	W	-15			
3φ4W		SEC:	2	CT:	1	UT:	1	REC	6

File Number

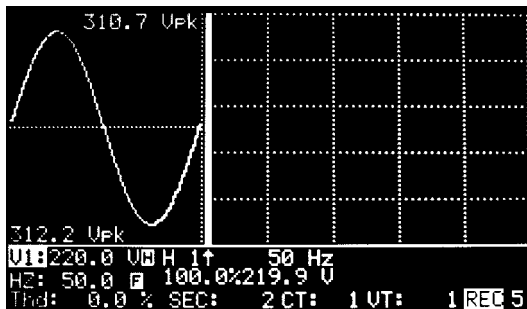

File Number

1. Press the **HOLD** button.
2. Press the **REC** button. It takes a few seconds to hardcopy the screen, and store the screen in memory.
3. The LCD will show **REC** in reverse video when in operation. The number following REC is the file number.
4. Users can store up to 85 screens (if no power or harmonics data is stored).

## READ the SAVED Data



1. Press the **SETUP** button. 'DOWN LOAD FILE' is displayed in reverse video. If the data in the selected file is a hardcopy of the screen, a leading symbol of **H** is displayed in reverse video.
2. Press the **▲** or **▼** to select the saved screen.
3. Press the HOLD/READ button to view the saved screen. Press HOLD again to close the saved screen.

**NOTE:** If the data saved in a specific file is a **HARDCOPY** of a screen, a leading symbol of **H** is displayed in reverse video.

## Set the CT and VT (PT) Ratio

Note: Typically, the CT and VT settings will remain set to 1.

If the user has connected an external CT (current) or VT (voltage) transformer onto the high voltage or high current power line and wants to measure the voltage or current in relation to the main line, the PQ3350 allows the user to set up a CT or VT transformer ratio.

```
Down Load File: 1:19
REC DATE: 5- 7-22 10:14:50
HZ: 50
VT: 1
CT: 1
SEC: 2
CLAMP: 100
MD TIME: 15
TRANS REF:110.0 V
SDUP: 5%

Year Month Date Hour Minute Second
2005 7 22 13 22 20
```

1. Press the **SETUP** button to enter Setup mode.
2. Press the **SETUP** button several times until CT or VT is shown in reverse video.
3. Press the **▲** or **▼** button to increment or decrement the value by 1. Holding the **▲** or **▼** button will speed up the process of incrementing or decrementing.
4. The CT ratio range is 1 to 600. The VT ratio range is 1 to 3000. Once the CT or VT (PT) is set, the voltage and current readings are as follows:

CURRENT (displayed) = CURRENT (measured) x CT Ratio

VOLTAGE (displayed) = VOLTAGE (measured) x VT Ratio

5. To exit Setup mode, press the EXIT button.

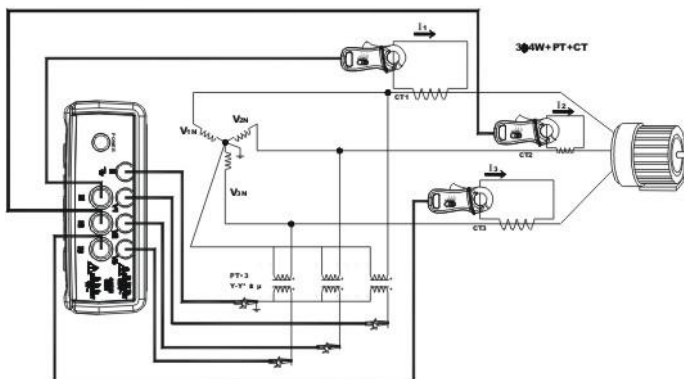

## Maximum Demand (MD)

```
Down Load File: 0 1:19
REC DATE: 5- 7-22 10:14:50
HZ: 50
VT: 1
CT: 1
SEC: 2
CLAMP: 100
MD TIME: 15
TRANS REF:110.0 V
SDUP: 5%

Year  Month  Date  Hour  Minute  Second
2005   7     22   13    22     55
```

Press the **SETUP** button to enter Setup mode.

Press the **SETUP** button until MD TIME is displayed in reverse video.

Press the ▲ or ▼ button to increment or decrement the value by 1.

Holding the ▲ or ▼ button will speed up the process of incrementing or decrementing. To exit, press the EXIT button.

The MD (max. demand) time interval range is 1 to 60 minutes. Once the time interval is set, the unit will calculate the maximum demand and average demand in watts (W) or VA. To toggle between W and VA, press the **POWER** button.



## SAMPLE TIME (Data Logging)

```
Down Load File: 1:19
REC DATE: 5- 7-22 10:14:50
HZ: 50
VT: 1
CT: 1
SEC: 2
CLAMP: 100
MD TIME: 15
TRANS REF:110.0 U
SOUP: 5%

Year Month Date Hour Minute Second
2005 7 22 13 22 25
```

Press the **SETUP** button to enter Setup mode.

Press the **SETUP** button several times until SEC is displayed in reverse video.

Press the ▲ or ▼ button to increment or decrement the value by 2.

Holding the ▲ or ▼ button will speed up the process of incrementing or decrementing.

To exit, press the **EXIT** button.

Examples:

3 phase power monitoring (17474 memory locations)

<u>Sample rate</u>	<u>How often</u>	<u>Duration</u>
2 seconds	30 /min, 1800/Hour,	9.7 hours
5 Seconds	12/min, 720/hour	24.2 hours
10 Seconds	6/min, 360/hour	48.5 hours

## Date and Time

```
Down Load File: 1:19
REC DATE: 5- 7-22 10:14:50
HZ: 50
UT: 1
CT: 1
SEC: 2
CLAMP: 100
MD TIME: 15
TRANS REF:110.0 U
SDUP: 5%
Year  Month  Date  Hour  Minute  Second
2005   7      22   13    23     20
```

```
Down Load File: 1:19
REC DATE: 5- 7-22 10:14:50
HZ: 50
UT: 1
CT: 1
SEC: 2
CLAMP: 100
MD TIME: 15
TRANS REF:110.0 U
SDUP: 5%
Year  Month  Date  Hour  Minute  Second
2005   7      22   13    23     33
```

```
Down Load File: 1:19
REC DATE: 5- 7-22 10:14:50
HZ: 50
UT: 1
CT: 1
SEC: 2
CLAMP: 100
MD TIME: 15
TRANS REF:110.0 U
SDUP: 5%
Year  Month  Date  Hour  Minute  Second
2005   7      22   13    23     40
```

```
Down Load File: 1:19
REC DATE: 5- 7-22 10:14:50
HZ: 50
UT: 1
CT: 1
SEC: 2
CLAMP: 100
MD TIME: 15
TRANS REF:110.0 U
SDUP: 5%
Year  Month  Date  Hour  Minute  Second
2005   7      22   13    23     52
```

```
Down Load File: 1:19
REC DATE: 5- 7-22 10:14:50
HZ: 50
UT: 1
CT: 1
SEC: 2
CLAMP: 100
MD TIME: 15
TRANS REF:110.0 U
SDUP: 5%
Year  Month  Date  Hour  Minute  Second
2005   7      22   13    24     0
```

1. Press the **SETUP** button to enter Setup mode.
2. Press the **SETUP** button to select (Year, Month, Date, Hour, and Minute).
3. Press the **▲** or **▼** to increment or decrement the number.

Note: The 'seconds' field cannot be adjusted.

## SPECIFICATIONS

### AC Watt

(50 or 60 Hz, PF 0.5 to 1, CT = 1, Voltage > AC 20V, Current > AC 40mA for 1A range, Current > AC 0.4A for 10A range, Current > AC 4A for 100A range, and continuous waveform)

#### Model PQ3350 + PQ3110 (100A)

Range (0 to 100A)	Resolution	Accuracy of Readings <sup>1</sup>
5.0 – 999.9 W	0.1W	±1% ± 0.8W
1.000 – 9.999 KW	0.001 KW	±1% ± 8W
10.00 – 99.99 KW	0.01 KW	±1% ± 80W
100.0 – 999.9 KW	0.1 KW	±1% ± 0.8KW
1000 – 9999 KW	1 KW	±1% ± 8KW

(50 or 60 Hz, PF 0.5 to 1, CT = 1, Voltage > AC 20V, Current > AC 4A for 100A range, Current > AC 40A for 1000A, and continuous waveform)

#### Model PQ3350 + PQ3120 (1000A)

Range (0 to 1000A)	Resolution	Accuracy of Readings <sup>2</sup>
5.0 – 999.9 W	0.1W	±1% ± 0.8W
1.000 – 9.999 KW	0.001 KW	±1% ± 8W
10.00 – 99.99 KW	0.01 KW	±1% ± 80W
100.0 – 999.9 KW	0.1 KW	±1% ± 0.8KW
1000 – 9999 KW	1 KW	±1% ± 8KW
0.000 – 9.999MW	0.001MW	±1% ± 80KW

(50 or 60 Hz, PF 0.5 to 1, CT = 1, Voltage > AC 5V, Current > AC 5A for A range, and continuous waveform. Conductor is located at the center of flexible loop. Position sensitivity is 2% of range. External field effect of < 40A/m and 200mm from the coupling is 1% of range. Temperature coefficient is 0.02% of reading / °C)

#### Model PQ3350 + PQ3220/PQ3210 (3000A/1200A)

Range (0 to 3000A/1200A)	Resolution	Accuracy of Readings <sup>3</sup>	
		> 20 V and > 30A	< 20V or < 30A
10.0 – 999.9 W	0.1W	±1% of range	±2% of range
1.000 – 9.999 KW	0.001 KW	±1% of range	±2% of range
10.00 – 99.99 KW	0.01 KW	±1% of range	±2% of range
100.0 – 999.9 KW	0.1 KW	±1% of range	±2% of range
1000 – 9999 KW	1 KW	±1% of range	±2% of range

<sup>1,2,3</sup> For CT ≠ 1, the accuracy in percentage is the same (±1%). But the additional digits should be multiplied by the CT ratio.

For example, ±0.8W becomes ±0.8W \* CT ratio

**Range of CT (Current Transformer) Ratio:** 1 to 600

**AC Apparent Power (VA, from 0.000VA to 9999 KVA):**

$$VA = V \text{ r.m.s.} \times A \text{ r.m.s.}$$

**AC Reactive Power (VAR, from 0.000 VAR to 9999 KVAR):**

$$VAR = \sqrt{(VA^2 - W^2)}$$

**AC Active Energy (mWH, WH, or KWH, from 0 mWH to 999,999 KWH)**

$$WH = W * \text{Time (in hours)}$$

## AC Current

(50 or 60 Hz, Auto Range, True RMS, Crest Factor < 4, CT=1)

**Model PQ3350+PQ3110 (Overload Protection AC 200A)**

Range	Resolution	Accuracy of Readings <sup>4</sup>
0.04 – 1 A	0.1mA/1mA	±0.5% ± 0.05A
0.4 – 10 A	0.001A/0.01A	±0.5% ± 0.05A
4 – 100 A	0.01 A/0.1A	±1.0% ± 0.5A

**Model PQ3350+PQ3120 (Overload Protection AC 2000A)**

Range	Resolution	Accuracy of Readings <sup>5</sup>
10.00A	0.001A/0.01A	–
4A - 100.0A	0.01A/0.1A	±0.5% ± 0.5A
40A – 1000.0 A	0.1A/1 A	±0.5% ± 5A

**Model PQ3350+PQ3220 (Overload Protection AC 3000A)**

Range	Resolution	Accuracy of Readings <sup>6</sup>
0 – 300.0A	0.1A	±1% of range
300.0 – 3000A	0.1A / 1A	±1% of range

**Model PQ3350+PQ3210 (Overload Protection AC 1200A)**

Range	Resolution	Accuracy of Readings <sup>6</sup>
0 – 120.0A	0.1A	±1% of range
120.0 – 1200A	0.1A / 1A	±1% of range

<sup>4,5,6</sup> For CT ≠ 1, the accuracy in percentage is the same (±0.5%). But the additional digits should be multiplied by the CT ratio.

For example, ±0.5A becomes ±0.5A \* CT ratio

## AC Voltage

(50 or 60 Hz, Auto Range, True RMS, Crest Factor < 4, Input Impedance 10 MΩ, VT (PT) = 1, Overload Protection AC 800V)

Range	Resolution	Accuracy of Readings <sup>7</sup>
20.0 V – 500.0 V (Phase to Neutral)	0.1 V	±0.5% ± 5dgt
20.0 V – 600.0 V (Phase to Phase)		±0.5% ± 5dgt

<sup>7</sup>For VT (PT) ≠1, the accuracy in percentage is the same (±0.5%). But the additional digits should be multiplied by the VT ratio.

For example, ±5 digits becomes ±5 digits \* VT (PT) ratio

## Harmonics of AC Voltage in Percentage

(1 to 99<sup>th</sup> order, minimum voltage at the 50 or 60 Hz > AC 80V. If the voltage is 0 at 50 or 60 Hz, all the percentage (%) display is 0.)

Range	Resolution	Accuracy
1 – 20 <sup>th</sup>	0.1%	±2%
21 – 49 <sup>th</sup>		±4% of reading ± 2.0%
50 – 99 <sup>th</sup>		±6% of reading ± 2.0%

## Harmonics of AC Voltage in Magnitude

(1 to 99<sup>th</sup> order, minimum voltage at the 50 or 60 Hz > AC 80V, VT=1)

Range	Resolution	Accuracy
1 – 20 <sup>th</sup>	0.1V	±2% ± 0.5V
21 – 49 <sup>th</sup>		±4% of reading ± 0.5V
50 – 99 <sup>th</sup>		±6% of reading ± 0.5V

## Harmonics of AC Current in Percentage

(1 to 99<sup>th</sup> order. Min. current at 50 or 60 Hz is: model PQ3350+PQ3110 > 10% of the range; model PQ3350+PQ3120 > 20A; model PQ3350+PQ3220/PQ3210 > 30A. If the current is 0 at 50 or 60 Hz, all the percentage (%) display is 0)

### Model PQ3350+PQ3110

Range	Resolution	Accuracy
1 – 10 <sup>th</sup>	0.1%	±0.2% of reading ± 1%
11 – 20 <sup>th</sup>		±2% of reading ± 1%
21 – 50 <sup>th</sup> (A range)		±5% of reading ± 1%
21 – 50 <sup>th</sup> (mA range)		±10% of reading ± 1%
51 – 99 <sup>th</sup>		±35% of reading ± 1%

**Model PQ3350+PQ3120**

Range	Resolution	Accuracy
1 – 20 <sup>th</sup>	0.1 %	±2%
21 – 49 <sup>th</sup>		±4% of reading ± 2.0%
50 – 99 <sup>th</sup>		±6% of reading ± 2.0%

**Model PQ3350 + PQ3220/PQ3210**

Range	Resolution	Accuracy
1 – 20 <sup>th</sup>	0.1%	±2%
21 <sup>st</sup> – 50 <sup>th</sup>	0.1%	±6%
51 <sup>st</sup> – 99 <sup>th</sup>	0.1%	±10%

**Harmonics of AC Current in Magnitude**

(1 to 99<sup>th</sup> order. Min. current at the 50 or 60 Hz: model PQ3350+PQ3110 > 10% of the range; model PQ3350+PQ3120 > 20A. CT=1)

**Model PQ3350+PQ3110**

Range	Resolution	Accuracy
1 – 10 <sup>th</sup>	0.1mA / 0.1A	±0.2% of reading ±7dgts
11 – 20 <sup>th</sup>		±2% of reading ±7dgts
21 – 50 <sup>th</sup> (A range)		±5% of reading ±7dgts
21 – 50 <sup>th</sup> (mA range)		±10% of reading ±7dgts
51 - 99 <sup>th</sup>		±35% of reading ±7dgts

**Model PQ3350+PQ3120**

Range	Resolution	Accuracy
1 – 20 <sup>th</sup>	0.1A	±2% of reading ±0.4A
21 – 49 <sup>th</sup>		±4% of reading ±0.4A
50 – 99 <sup>th</sup>		±6% of reading ±0.4A

(1 to 99<sup>th</sup> order, min. current at the 50 or 60 Hz, True RMS < 300A)

**Model PQ3350+PQ3220/PQ3210**

Range (0 – 300A)	Resolution	Accuracy
1 – 20 <sup>th</sup>	0.1%	±2% of reading ± 4A
21 <sup>st</sup> – 50 <sup>th</sup>	0.1%	±4% of reading ± 4A
51 <sup>st</sup> – 99 <sup>th</sup>	0.1%	±6% of reading ± 4A

(1 to 99<sup>th</sup> order, min. current at the 50 or 60 Hz, 3000A > True RMS > 300A)

**Model PQ3350+PQ3220/PQ3210**

Range (300 – 3000A)	Resolution	Accuracy
1 – 20 <sup>th</sup>	0.1%	±2% of reading ± 40A
21 <sup>st</sup> – 50 <sup>th</sup>	0.1%	±4% of reading ± 40A
51 <sup>st</sup> – 99 <sup>th</sup>	0.1%	±6% of reading ± 40A

## Power Factor (PF)

### Model PQ3350+PQ3110 or PQ3350+PQ3120

Range	Resolution	Accuracy
0.00 – 1.00	0.01	± 0.04

### Model PQ3350+PQ3220/PQ3210

Range	Resolution	Accuracy	
		> 20V and > 30A	< 20V or < 30A
0.000 – 1.000	0.001	± 0.04	± 0.1

## Phase Angle ( $\Phi$ )

### Model PQ3350+PQ3110 or PQ3350+PQ3120

Range	Resolution	Accuracy
-180° to 180°	0.1°	± 1°

### Model PQ3350+PQ3220/PQ3210 ( $\Phi$ , V > 20V, A > 30A)

Range	Resolution	Accuracy
-180° to 180°	0.1°	± 2°
0° to 360°	0.1°	± 2°

## Peak Value

of **ACV** (peak value > 20V) or **ACA** (peak value: model PQ3350+PQ3110> 10% of the range; model PQ3350+PQ3120> 20A; model PQ3350+PQ3220/PQ3210> 30A), **VT=1**

Range	Sampling Time	Accuracy of Reading
50 Hz	19 $\mu$ s	± 5% ± 30 digits
60 Hz	16 $\mu$ s	± 5% ± 30 digits

## Crest Factor (C.F.)

of **ACV** (peak value >20V) or **ACA** (peak value: model PQ3350+PQ3110> 10% of the range; model PQ3350+PQ3120> 20A; model PQ3350+PQ3220/PQ3210> 30A), **VT=1**

Range	Resolution	Accuracy of Readings
1.00 – 99.99	0.01	± 5% ± 30 digits

## Frequency

in AUTO mode

### Model PQ3350+PQ3110 or PQ3350+PQ3120

Range	Resolution	Accuracy of Reading
45 – 65 Hz	0.1Hz	0.1Hz

## Frequency

of ACV (RMS value > 10V) or ACA (RMS value > 30A)

### Model PQ3350+PQ3220/PQ3210

Range	Resolution	Accuracy
45 – 65 Hz	0.1 Hz	± 0.2Hz

## Total Harmonic Distortion

(THD-F with respect to the fundamental frequency, min. value at 50 or 60 Hz is voltage > AC 80V and current is: model PQ3350+PQ3110> 10% of the range; model PQ3350+PQ3120> 20A; model PQ3350+PQ3220/PQ3210> 30A. Calculation is done over 1 to 50<sup>th</sup> Harmonics. If the voltage or current is 0 at 50 or 60 Hz, all the percentage (%) display is 0).

### Model PQ3350 + PQ3110

Range	Resolution	Accuracy
0.0 – 20.0 %	0.1%	± 1%
20.0 – 100%		±3% of reading ± 5%
100 – 999.9%		±10% of reading ±10%

### Model PQ3350 + PQ3120

Range	Resolution	Accuracy
0.0 – 20%	0.1%	± 2%
20 – 100%		± 6% of reading ± 1%
100 – 999.9 %		± 10% of reading ± 1%

### Model PQ3350 + PQ3220/PQ3210

Range	Resolution	Accuracy
0.0 – 20%	0.1%	± 2%
20 – 100%	0.1%	± 6% of reading ± 5%
100 – 999.9 %	0.1%	± 10% of reading ± 10%



## **PQ3350 Analyzer**

Indoors Use

Battery Type:	1.5V SUM-3 x 8
External DC Input:	<b>Use only power supply adapter Model PHAPSA</b>
Display:	Dot Matrix LCD (240x128) with backlight
LCD Update Rate:	1 time / second
Power Consumption:	140mA (approx.)
No. Of Samples:	1024 samples / period
Data Logging Files:	85
Memory Capacity:	17474 records (3P4W, 3P3W) 26210 records (1P3W) 52420 records (1P2W) 4096 records (50 Harmonics / record)
Sampling Time:	2 to 6000 seconds for data logging
Low battery Indication:	
Overload Indication:	OL
Operating Temperature:	-10°C to 50°C
Operating Humidity:	less than 85% relative
Storage Temperature:	-20°C to 60°C
Storage Humidity:	less than 75% relative
Dimension:	257(L) x 155(W) x 57(H) mm 10.1"(L) x 6.1"(W) x 2.3"(H)
Weight:	1160g (Batteries included)
Accessories:	test leads (3 meter long) x 4 Probes (PQ3110 or PQ3120 or PQ3220 or PQ3210) x 3 Alligator clips x 4 Carrying bag x 1 Users manual x 1 Batteries 1.5V x 8 USB to RS232 cable x 1

## **PQ3110 100A Current Probe**

Conductor Size:	1.2" (30mm) approx.
Range Selection:	Manual (1A, 10A, 100A)
Frequency range	45 to 65 Hz
Dimensions :	210mm (L) x 62mm (W) x 36mm (H) 8.3" (L) x 2.5" (W) x 1.4" (H)
Weight:	7 oz. (200g)
Operating Temperature:	14 to 122°F (-10°C to 50°C)
Operating Humidity:	< 85% relative humidity
Altitude:	< 2000 meters
Storage Temperature:	-4 to 140°F (-20°C to 60°C)
Storage Humidity:	< 75% relative

## **Model PQ3120 1000A Current Probe**

Conductor Size:	2.2" (55mm), 2.5" x 1.0" (64 x 24mm) bus bar
Range Selection:	Manual (10A, 100A, 1000A)
Frequency range	45 to 65 Hz
Dimensions:	244mm (L) x 97mm (W) x 46mm (H) 9.6" (L) x 3.8" (W) x 1.8" (H)
Weight:	1.3 lbs. (600g)
Operating Temperature:	14 to 122°F (-10°C to 50°C)
Operating Humidity:	< 85% relative humidity
Altitude:	< 2000 meters
Storage Temperature:	-4 to 140°F (-20°C to 60°C)
Storage Humidity:	< 75% relative

## Model PQ3210 1200A Flexible Current Probe

Probe Length:	18" (460mm)
Range Selection:	Manual (120A, 1200A)
Frequency range	45 to 65 Hz
Minimum Bending Diameter	1.37" (35mm)
Connector Diameter	0.9" (23mm)
Cable Diameter	0.55" (14mm)
Cable Length	67"/1700mm (probe to box) 67"/1700mm (box to output)
Dimensions (box):	5.1" (L) x 3.1" (W) x 1.7" (H) 130mm (L) x 80mm (W) x 43mm (H)
Weight:	13.8 oz. (390g)
Operating Temperature:	14 to 122°F (-10°C to 50°C)
Operating Humidity:	< 85% relative humidity
Altitude:	< 2000 meters
Storage Temperature:	-4 to 140°F (-20°C to 60°C)
Storage Humidity:	< 85% relative

## Model PQ3220 3000A Flexible Current Probe

Probe Length:	24" (610mm)
Range Selection:	Manual (300A, 3000A)
Frequency range	45 to 65 Hz
Minimum Bending Diameter	1.37" (35mm)
Connector Diameter	0.9" (23mm)
Cable Diameter	0.55" (14mm)
Cable Length	67"/1700mm (probe to box) 67"/170mm (box to output)
Dimensions (box):	5.1" (L) x 3.1" (W) x 1.7" (H) 130mm (L) x 80mm (W) x 43mm (H)
Weight:	14.4 oz. (410g)
Operating Temperature:	14 to 122°F (-10°C to 50°C)
Operating Humidity:	< 85% relative humidity
Altitude:	< 2000 meters
Storage Temperature:	-4 to 140°F (-20°C to 60°C)
Storage Humidity:	< 85% relative

# BATTERY REPLACEMENT

---

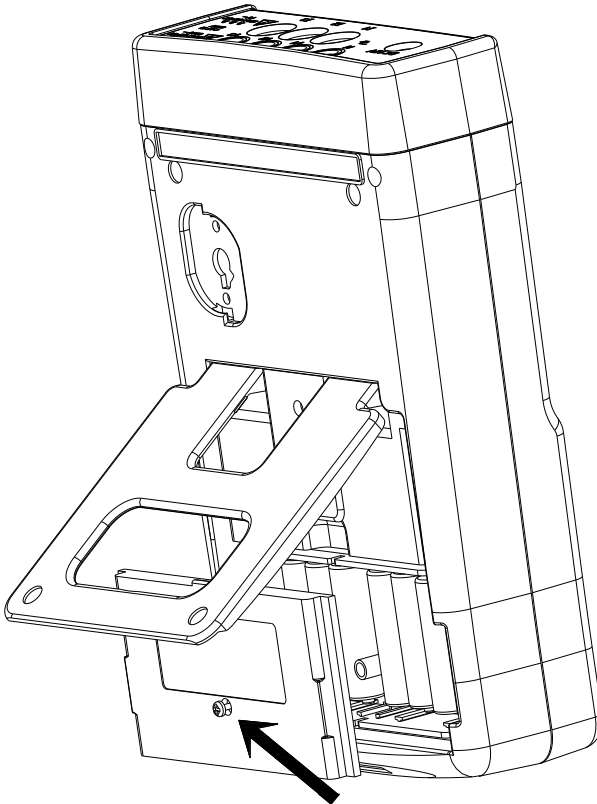

When the low battery symbol is displayed on the LCD, replace the batteries.

1. Turn power off and remove all of the test leads and current probes from the unit.
2. Remove the screw on the battery cover.
3. Lift and remove the battery cover.
4. Remove the old batteries.
5. Insert eight (8) new 1.5V 'AA' batteries.
6. Replace the battery cover and secure the screw.

## ***MAINTENANCE & CLEANING***

---

Service not covered in this manual should only be performed by qualified personnel. Repairs should only be performed by qualified personnel. Periodically wipe the case with a damp cloth and detergent; do not use abrasives or solvents.

## ***NOMENCLATURE***

---

V12, V23, V31: Line Voltage  
V1, V2, V3: Phase Voltage  
I1, I2, I3: Line Current  
P1, P2, P3: True Power (W) of Each Phase  
S1, S2, S3: Apparent (VA) Power of Each Phase  
Q1, Q2, Q3: Reactive Power (VAR) of Each Phase  
PΣ: Total System Power (W)  
SΣ: Total System Apparent Power (VA)  
QΣ: Total Reactive Power (VAR)  
PFΣ: Total System Power Factor (PF)  
PF1, PF2, PF3: Power Factor of Each Phase  
PFH: Long Term Average Power Factor (WH / SH)  
Φ1, Φ2, Φ3: Phase Angle of Each Phase  
WH: Watt Hours  
SH: VA hours  
QH: VAR hours  
HZ: Selected Frequency 50, 60 or Auto.  
MD: Maximum Demand in W and VA over Specified Interval  
3P4W: 3 Phase 4 Wire System  
3P3W: 3 Phase 3 Wire System  
1P2W: Single Phase 2 Wire System  
1P3W: Single Phase 3 Wire System  
SEC: sampling interval (0 to 3000 seconds) for data logging  
CT: Current Transformer Ratio from 1 to 600  
VT: Voltage Transformer Ratio from 1 to 3000



## **Two-year Warranty**

---

**FLIR Systems, Inc. warrants this Extech brand instrument to be free of defects in parts and workmanship for **two years** from date of shipment (a six-month limited warranty applies to sensors and cables). To view the full warranty text please visit: <https://www.extech.com/warranty>.**

## **Calibration and Repair Services**

---

**FLIR Systems, Inc. offers calibration and repair services** for the Extech brand products we sell. We offer NIST traceable calibration for most of our products. Contact us for information on calibration and repair availability, refer to the contact information below. Annual calibrations should be performed to verify meter performance and accuracy. Product specifications are subject to change without notice. Please visit our website for the most up-to-date product information: [www.extech.com](http://www.extech.com).

## **Contact Customer Support**

---

**Customer Support Telephone:** U.S. (866) 477-3687; International +1 (603) 324-7800

**Calibration, Repair, and Returns email:** [repair@extech.com](mailto:repair@extech.com)

**Technical Support:** <https://support.flir.com>

**Copyright © 2022 Teledyne FLIR Commercial Systems, Inc.**

All rights reserved including the right of reproduction in whole or in part in any form

**[www.extech.com](http://www.extech.com)**

This document does not contain any export-controlled information