

# FLIR CM72 and CM74 CLAMP METERS

CM72 600A True RMS AC Clamp Meter

CM74 600A True RMS AC/DC Clamp Meter

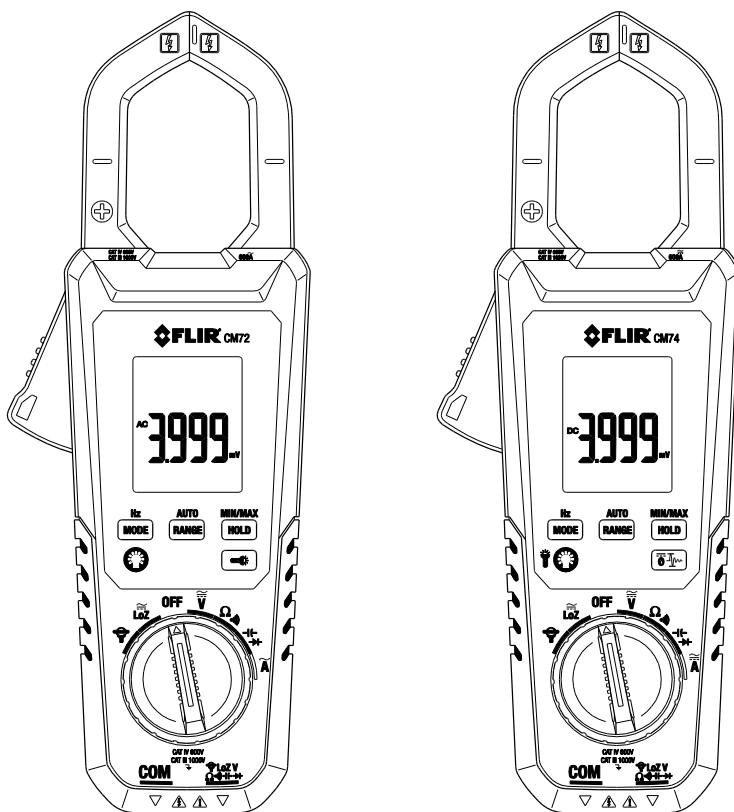

# Table of Contents

---

<b>1. DISCLAIMERS</b>	<b>4</b>
1.1 Copyright	4
1.2 Quality Assurance	4
1.3 Documentation	4
1.4 Disposal of Electronic Waste	4
<b>2. SAFETY</b>	<b>5</b>
<b>3. INTRODUCTION</b>	<b>7</b>
3.1 Key Features	7
<b>4. METER DESCRIPTION</b>	<b>8</b>
4.1 Meter Parts	8
4.2 Function Switch	9
4.3 Function Buttons	9
4.4 Display Icons and Indicators	10
<b>5. OPERATION</b>	<b>12</b>
5.1 Powering the Meter	12
5.1.1 Auto Power Off	12
5.2 Auto/Manual Range Mode	12
5.3 HOLD Mode	12
5.4 Voltage and Current Measurements	13
5.4.1 Basic Voltage Measurements	13
5.4.2 'Lo Z' Voltage Measurements	13
5.4.3 Basic Current Measurements	14
5.4.4 Extended Functionality Modes	15
5.4.4.1 Inrush Current Mode (CM74 only)	15
5.4.4.2 DCA Zero Mode (CM74 only)	16
5.4.4.3 Frequency Mode	16
5.4.4.4 MIN/MAX Mode	16

5.4.4.5 VFD Mode (low pass filter) CM74 only	16
5.4.4.6 Flex Clamp Adaptor Use	17
5.5 Resistance Measurements	18
5.6 Continuity Test	18
5.7 Capacitance Measurements	19
5.8 Diode Test	20
<b>6. MAINTENANCE</b>	<b>21</b>
6.1 Cleaning and Storage	21
6.2 Battery Replacement	21
<b>7. SPECIFICATIONS</b>	<b>22</b>
7.1 General specifications	22
7.2 Electrical specifications	23
<b>8. TECHNICAL SUPPORT</b>	<b>28</b>
<b>9. WARRANTIES</b>	<b>29</b>
9.1 FLIR Global Limited Lifetime Warranty	29

# 1. Disclaimers

---

## 1.1 Copyright

© 2020, FLIR Systems, Inc., All rights reserved worldwide. No parts of the software including source code may be reproduced, transmitted, transcribed or translated into any language or computer language in any form or by any means, electronic, magnetic, optical, manual or otherwise, without the prior written permission of FLIR Systems.

The documentation must not, in whole or part, be copied, photocopied, reproduced, translated or transmitted to any electronic medium or machine-readable form without prior consent, in writing, from FLIR Systems.

Names and marks appearing on the products herein are either registered trademarks or trademarks of FLIR Systems and/or its subsidiaries. All other trademarks, trade names or company names referenced herein are used for identification only and are the property of their respective owners.

## 1.2 Quality Assurance

The Quality Management System under which these products are developed and manufactured has been certified in accordance with the ISO 9001 standard.

FLIR Systems is committed to a policy of continuous development; therefore, we reserve the right to make changes and improvements on any of the products without prior notice.

## 1.3 Documentation

To access the latest manuals and notifications, go to the Download tab at: <https://support.flir.com>. It only takes a few minutes to register online. In the download area you will also find the latest releases of manuals for our other products, as well as manuals for our historical and obsolete products.

## 1.4 Disposal of Electronic Waste



As with most electronic products, this equipment must be disposed of in an environmentally friendly way, and in accordance with existing regulations for electronic waste.



Please contact your FLIR Systems representative for more details.

## 2. Safety

---

### Safety Notes

- Before operating the device, you must read, understand, and follow all instructions, dangers, warnings, cautions, and notes.
- FLIR Systems reserves the right to discontinue models, parts or accessories, and other items, or to change specifications at any time without prior notice.
- Remove the batteries if the device is not used for an extended period of time.





### Warning Statements

- Do not operate the device if you do not have the correct knowledge. Formal qualifications and/or national legislation for the electrical inspections can apply. Incorrect operation of the device can cause damage, shock, injury or death to persons.
- Do not start the measuring procedure before you have set the function switch to the correct position. This can cause damage to the instrument and can cause injury to persons.
- Do not change to current or resistance when you measure the voltage. This can cause damage to the instrument and can cause injury to persons.
- Do not measure the current on a circuit when the voltage increases to more than 1000 V. This can cause damage to the instrument and can cause injury to persons.
- You must disconnect the test leads from the circuit that you did a test on before you change the range. If you do not do this, damage to the instrument and injury to persons can occur.
- Do not replace the batteries before you remove the test leads. This can cause damage to the instrument and can cause injury to persons.
- Do not use the device if the test leads and/or the device show signs of damage. Injury to persons can occur.
- Be careful when taking measurements if the voltages are more than 25 VAC rms or 35 VDC. There is a risk of shock from these voltages. Injury to persons can occur.
- Do not do diode, resistance or continuity tests before you have removed the power from capacitors and other devices under test during a measurement. Injury to persons can occur.
- Make sure that children cannot touch the device. The device contains dangerous objects and small parts that children can swallow. If a child swallows an object or a part, speak with a physician immediately. Injury to persons can occur.
- Do not let children play with the batteries and/or the packing material. These can be dangerous for children if they use them as toys.
- Do not touch expired or damaged batteries without gloves. Injury to persons can occur.
- Do not cause a short circuit of the batteries. This can cause damage to the instrument and can cause injury to persons.
- Do not put the batteries into a fire. Injury to persons can occur.

## Cautions

Do not use the device for a procedure that it is not intended for. This can cause damage to the protection.

	This symbol, adjacent to another symbol or terminal, indicates that the user must refer to the manual for further information.
	This symbol, adjacent to a terminal, indicates that, under normal use, hazardous voltages may be present.
	Double insulation.



UL listing is not an indication or a verification of the accuracy of the meter

### 3. Introduction

---

Thank you for selecting the FLIR CM72\_CM74 Clamp Meter. The CM72 is a True RMS 600A AC Clamp Meter and the CM74 is a True RMS 600A AC/DC clamp meter with integrated VFD Mode, Inrush Current capture. Both meters have a Lo Z mode for eliminating 'ghost' voltages. This device is shipped fully tested and calibrated and, with proper use, will provide years of reliable service.

#### 3.1 Key Features

- 6000-count digital display
- Large-scale 2.0" backlit display
- Work light
- Auto Range True RMS AC 600 A capability and selection CM72
- Auto Range True RMS AC/DC 600 A capability and selection CM74
- Auto Range True RMS AC/DC 600 V capability and selection
- Frequency AC bandwidth (45-400Hz)
- Frequency Measurements to 60KHz
- Flex Clamp adaptor input for FLIR TA72\_TA74 Clamp adaptors
- Resistance and Continuity measurements
- Capacitance and Diode measurements
- Data hold
- Inrush current (CM74 only)
- DCA zero function (CM74 only)
- Low Z (Impedance) mode for both models CM72 and CM74
- Minimum/Maximum HOLD memory
- Integrated VFD mode (Low-pass filter) CM74 only
- Auto power off
- Jaw opening 35mm (1.38")
- Easy-access battery cover mechanism
- Safety Category Rating: CAT IV-600V, CAT III-1000V

## 4. Meter Description

### 4.1 Meter Parts

1. Jaw opening trigger
2. **Hz-MODE** button
3. Backlight/Work light button (CM74);  
Backlight button only (CM72)
4. Function switch
5. COM (negative -) Probe Input jack
6. Positive (+) Probe Input jack
7. DCA Zero and Inrush button (CM74 only)  
Work light button (CM72)
8. **MIN/MAX HOLD** button
9. **AUTO-RANGE** Button
10. LCD Display
11. Clamp jaw

Fig 4-1 Front View

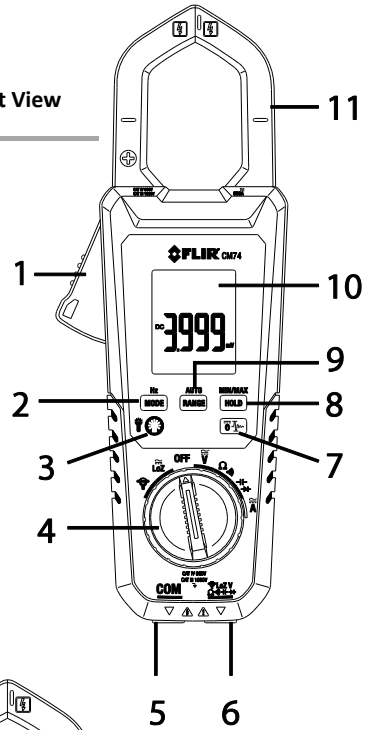
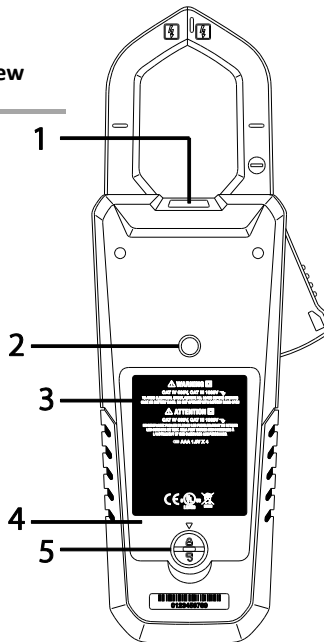







Fig 4-2 Rear View

1. Work light
2. Tripod mount
3. Warning text
4. Battery compartment
5. Battery compartment lock











## 4.2 Function Switch

	Select this position when connecting a FLIR Flex Clamp Adaptor.
	Select this position to measure in the low impedance mode.
<b>OFF</b>	Select this position to switch the meter OFF (full power saving mode).
	Select this position to measure AC/DC Voltage through the probe inputs.
	The meter can measure resistance and continuity through the probe inputs. The type of measurement is selected by the MODE button.
	The meter can measure capacitance and diode through the probe inputs. The type of measurement is selected by the MODE button.
	Amps AC/DC (CM74) and Amps AC only (CM72). The meter can measure current through the clamp jaws.

## 4.3 Function Buttons













	Select AC or DC in the Voltage/Current modes. Select Diode or Capacitance; Continuity or Resistance. Select Hz in the AC Voltage/Current/FLEX modes.
	Select Auto or Manual range mode, see section 5.3 <i>Auto/Manual range mode</i> In Manual mode, press to change the range (scale); to return to Auto range mode from Manual mode, press and hold for > 2 seconds.
	Toggle normal and Hold modes, see section 5.4 <i>Hold mode</i> Press for > 2 seconds to enable/disable MIN/MAX mode. While in MIN/MAX mode, short presses step MIN>MAX>MIN. Press and hold for >2 seconds to exit the MIN/MAX mode.
	For the CM74: Press to enable/disable the display backlight. Press and hold for > 2 seconds to switch the Work Light ON/OFF.
	For the CM72 press to enable/disable the LCD backlight.
	For the CM72 press to enable/disable the Work Light.
	For the CM74 only. In the DCA mode, press to zero the display. In the ACA mode press to enable the inrush current mode.





## 4.4 Display Icons and Indicators



Fig 4-3 Display Icons

Refer to Fig. 4-3 above for the display icon descriptions below:

	Indicates that the meter is displaying maximum reading values.
	Indicates that the meter is displaying minimum reading values.
	Indicates that the meter is in Auto range mode.
	Indicates that the meter is in Hold mode.
	Indicates the battery voltage status.
	Indicates that the auto power off function is enabled.
	Indicates that the measured voltage is greater than 30 V DC or AC RMS.
	Indicates that the meter is measuring AC current or voltage.
	Indicates that meter is measuring DC current or voltage (DCA CM74 only).
	Indicates that the continuity function is active.
	Indicates that the diode test function is active.
	Ohm symbol. Unit of measure for Resistance and Continuity.

<b>A</b>	Unit of measure for current (Amps or Amperes).
<b>V</b>	Volt. Unit of measure for Voltage.
<b>F</b>	Farad. Unit of measure for Capacitance.
<b>Hz</b>	Hertz. Unit of measure for Frequency.
<b>k</b>	$10^3$ (kilo)
<b>m</b>	$10^{-3}$ (milli)
<b>μ</b>	$10^{-6}$ (micro)
	VFD mode icon (CM74 only).
	DC Zero mode icon (CM74 only).
	Inrush current mode icon (CM74 only).
	Flex Clamp Adaptor (FLIR TA72_TA74) icon.
<b>100 mV/A</b>	100mV/Ampere Clamp Adaptor icon.
<b>LoZ</b>	Lo Z mode icon.

#### 4.4.1 Out-of-range Warning

If the input is out-of-range, OL is displayed.

## 5. Operation

---

**Note:** Before operating the device, you must read, understand, and follow all instructions, dangers, warnings, cautions, and notes.

**Note:** When the meter is not in use, the function switch should be set to the **OFF** position.

**Note:** When connecting the probe leads to the device under test, connect the negative lead before connecting the positive lead. When removing the probe leads, remove the positive lead before removing the negative lead.

### 5.1 Powering the Meter

1. Set the function switch to any position to switch the meter ON.
2. If the battery indicator  shows that the battery voltage is low or if the meter does not power on, replace the batteries. See section 6.2 *Battery replacement*.

#### 5.1.1 Auto Power Off

The meter enters sleep mode after 10 minutes of inactivity. The meter beeps three times before powering off. Press any button or turn the function switch to prevent the meter from powering off. The auto power off time-out is then reset. To disable auto power off press the MODE button while turning the meter ON. The APO icon  is displayed when APO is active.

### 5.2 Auto/Manual Range Mode

In Auto range mode, the meter automatically selects the most appropriate measurement scale. In Manual range mode, the desired range (scale) can be set manually.

Auto range mode is the default mode of operation. When a new function is selected with the function switch, the starting mode is Auto range and the  indicator is displayed.

To enter Manual range mode, press the **RANGE** button. To change the range, press the **RANGE** button repeatedly until the desired range is displayed.

To return to Auto range mode from Manual mode, press and hold the **RANGE** button until the  indicator is displayed.

### 5.3 HOLD Mode

1. In Hold mode, the display freezes the last reading and continues to display this value.
2. Press the **HOLD** button to toggle between Normal and Hold modes. In Hold mode, the  indicator is displayed.

## 5.4 Voltage and Current Measurements

**Note:** If the measured voltage is greater than 30 V DC or AC RMS, the  indicator is displayed.

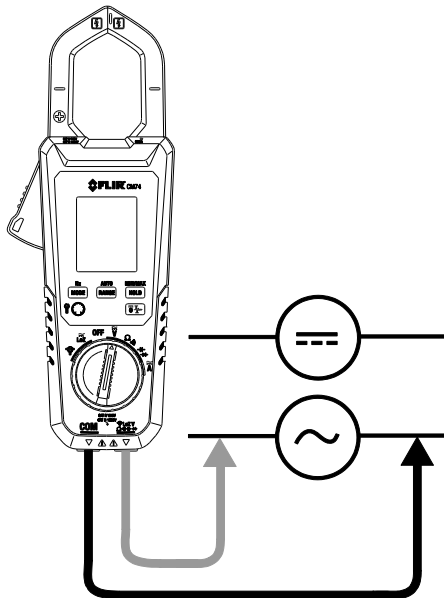

### 5.4.1 Basic Voltage Measurements

1. Set the function switch to the **V** position.
2. To manually select AC or DC, press the **MODE** button.
3. To manually select the measurement range (scale), press the **RANGE** button repeatedly. Refer to section 5.2 *Auto/Manual range mode*.
4. Insert the black probe lead into the negative COM terminal and the red probe lead into the positive V terminal.
5. Connect the probe leads in parallel to the part under test.
6. Read the voltage value on the display.



**Figure 5.1** Voltage Measurements

### 5.4.2 'Lo Z' Voltage Measurements

When the function switch is turned to the  position, the meter incorporates a low impedance circuit that eliminates ghost voltages. The low impedance is approx. 2.5k $\Omega$ . To take voltage measurements in the Lo Z mode, select the  function switch position and follow the voltage measurement instructions in the previous section.

### 5.4.3 Basic Current Measurements

**WARNING** Do not measure the current on a circuit when the voltage increases to more than 600V (CM72) or 1000V (CM74). This can cause damage to the instrument and can cause injury to persons.

When measuring current using the clamp jaws, only one conductor should be enclosed by the jaws—refer to Figure 5.2.

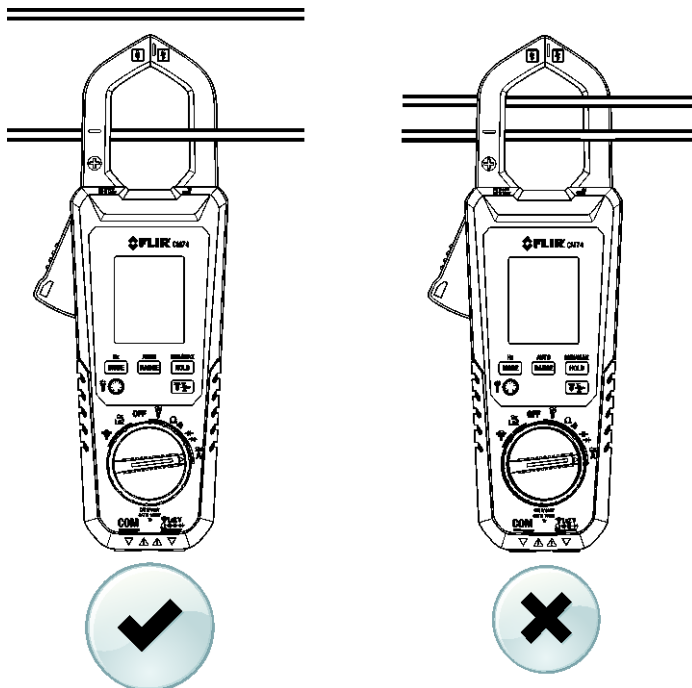

**Figure 5.2** Correct and incorrect setup

1. Ensure that the probe leads are disconnected from the meter.
2. Set the function switch to the **A** position.
3. To manually select AC or DC press the **MODE** button repeatedly. DCA is only available on the CM74.
4. To manually select the measurement range (scale), press the **RANGE** button repeatedly. Refer to section 5.3 *Auto/Manual range mode*.
5. Press the trigger to open the clamp jaws. Fully enclose one conductor—refer to Figure 5.2. For optimum results, center the conductor in the jaws.
6. Read the current value on the display.

## 5.4.4 Extended Functionality Modes

In addition to the basic measurements that the CM72 and CM74 can perform, a variety of extended functions are included. Refer to the following sections for details.

### 5.4.4.1 Inrush Current Mode (CM74 only)

In Inrush current mode, the meter displays the highest AC current reading in the first 100ms period after the trigger point (current detection threshold) is reached, see Fig. 5.3 below. The current detection threshold is 0.5A for the 60.00A range and 5.0A for the 600.0A range. Inrush current mode is available when measuring AC current.

1. Connect the meter to the unpowered circuit under test
2. Set the meter to **A**
3. Press the Inrush button  to enable the Inrush current mode. The Inrush display icon will appear on the LCD.
4. Turn on the power to the circuit under test
5. When the threshold is reached, the meter will display the RMS reading for the 100ms integration time.

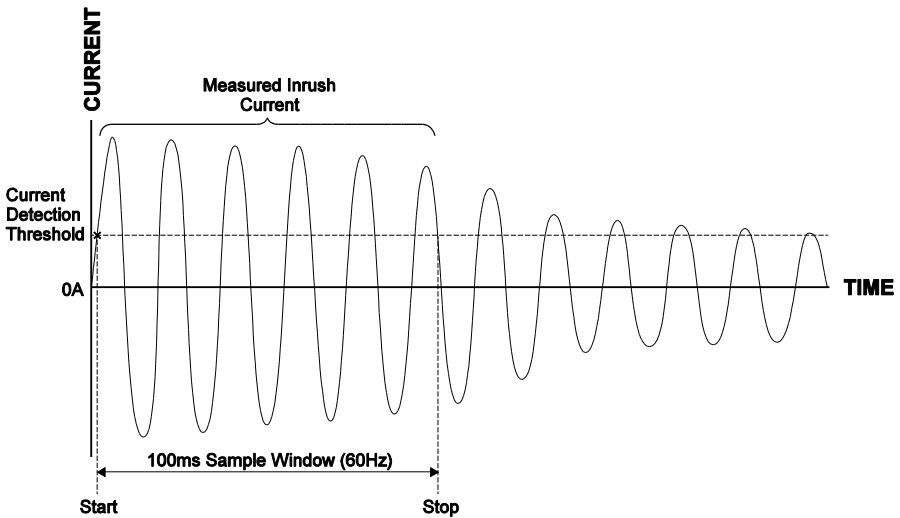



Figure 5.3 Inrush Current

#### 5.4.4.2 DCA Zero Mode (CM74 only)

The DC zero feature removes offset values and improves the accuracy for DC current measurements.

1. Ensure that there is no conductor in the clamp jaws.
2. Press the DCA Zero button  to enable DC Zero. The display will zero.

#### 5.4.4.3 Frequency Mode



In Frequency mode, the meter measures and displays the frequency. Frequency mode is available when measuring AC current or voltage.

**Important note: Do not switch to the Frequency mode until the meter is setup and actively measuring the voltage or current signal.**

Press and hold the MODE button to select **Hz** and enable Frequency mode.

#### 5.4.4.4 MIN/MAX Mode

In MIN/MAX mode, the meter captures and displays the Minimum and Maximum readings and updates only when a higher/lower value is registered.

1. Press and hold the **HOLD** button to access the MIN/MAX mode.
2. The first screen will be the MIN screen. The down arrow  will appear (indicating MIN mode) and the displayed reading will represent the lowest reading encountered since the **HOLD** button was first pressed.
3. Press the **HOLD** button again; this next screen will be the MAX display. The up arrow  will appear (indicating MAX mode) and the displayed reading will represent the highest reading encountered since the **HOLD** button was first pressed.
4. Continue to use the **HOLD** button to toggle the MIN/MAX readings as desired.
5. Press and hold the **HOLD** button for 2 seconds to exit the MIN/MAX mode. The meter will return to normal operation and the MIN/MAX memories will be reset.

#### 5.4.4.5 VFD Mode (low pass filter) CM74 only

The VFD mode eliminates high frequency noise in voltage measurements by means of a low-pass filter. The VFD mode is designed for variable frequency drive (VFD) measurements. This mode is always active for AC measurements. The VFD display icon is always displayed  when AC Current or AC Voltage modes are selected.



#### 5.4.4.6 Flex Clamp Adaptor Use

A FLIR Clamp Adaptor (Models TA72 and TA74) can be connected to the CM72 or CM74 to display current measurements made by the FLEX Clamp Adaptor.

1. Turn the function dial to the  position.
2. Connect the Flex Clamp as shown.
3. Set the Range of the Flex Clamp Adaptor to match the range of the CM174.
4. Operate the Flex Clamp per instructions provided with the Flex Clamp meter.
5. Read the current measured by the Flex Clamp on the CM72 or CM74 LCD.

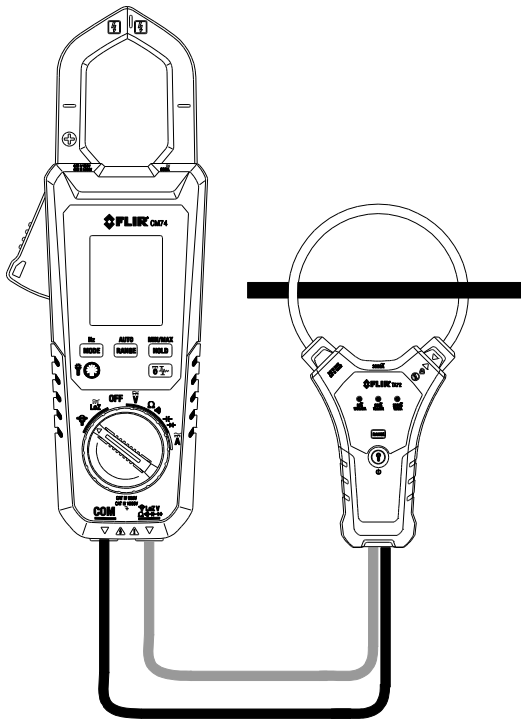
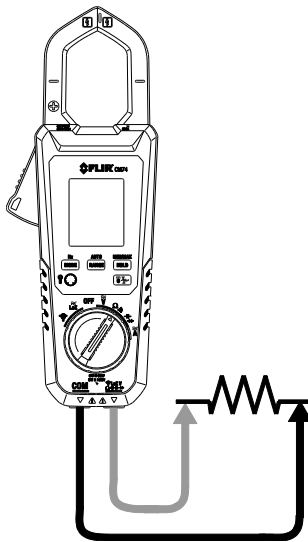

**Figure 5.4** Connecting a FLIR Flex Clamp Adaptor

## 5.5 Resistance Measurements

**Warning:** Do not perform resistance tests before removing the power from resistors and other devices under test during a measurement. Injury to persons can occur.

1. Set the function switch to the  $\Omega$  position.
2. Use the **MODE** button to select the resistance mode (continuity symbol  $\bullet\))$  should be OFF).
3. Insert the black probe lead into the negative COM terminal and the red probe lead into the positive  $\Omega$  terminal.
4. Touch the tips of the probe across the circuit or component under test.
5. Read the resistance value on the display.



**Figure 5.5** Resistance and Continuity Measurements

## 5.6 Continuity Test

**Warning:** Do not perform continuity tests before removing the power to the component, circuit, or other device under test during a measurement. Injury to persons can occur.

1. Set the function switch to the  $\bullet\))$  position.
2. Insert the black probe lead into the negative COM terminal and the red probe lead into the positive  $\Omega$  terminal. Refer to Fig. 5-5 for connection example.
3. Use the **MODE** button to select continuity measurement. The  $\bullet\))$  indicator will be displayed.
4. Touch the tips of the probe across the circuit or component under test.
5. If the resistance is lower than 30  $\Omega$ , the meter will beep.

## 5.7 Capacitance Measurements

**Warning:** Do not perform capacitance tests before removing the power to the capacitor or to other devices under test during a measurement. Injury to persons can occur.

1. Set the function switch to the  $\text{--}\text{||}\text{--}$  position.
2. Use the **MODE** button to select capacitance function (capacitor symbol must be displayed).
3. Insert the black probe lead into the negative COM terminal and the red probe lead into the positive  $\text{--}\text{||}\text{--}$  terminal.
4. Touch the tips of the probe across the part under test.
5. Read the capacitance value on the display.

**Note:** For very large capacitance values, several seconds may be required for the measurement to settle and for the final reading to stabilize.

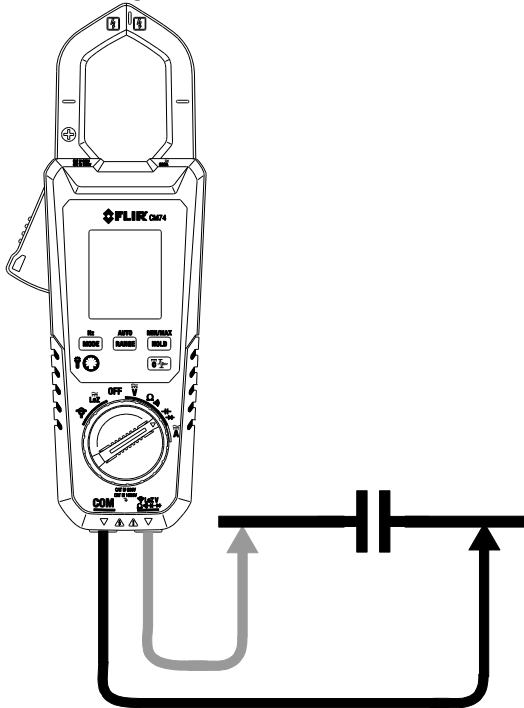

**Figure 5.6** Capacitance Measurements

## 5.8 Diode Test

**Warning:** Do not perform diode tests before removing the power to the diode or other devices under test during a measurement. Injury to persons can occur.

1. Set the function switch to the diode  $\rightarrow+$  position.
2. Insert the black probe lead into the negative COM terminal and the red probe lead into the positive  $\Omega$  terminal.
3. Use the **MODE** button to select the diode test function. The diode indicator  $\rightarrow+$  will be displayed.
4. Touch the tips of the probe across the diode or semiconductor junction under test.
5. If the reading is between 0.40 and 0.80V in one direction and OL (overload) in the opposite direction, the component is good. If the measurement is 0V in both directions (shorted) or OL in both directions (open), the component is bad.

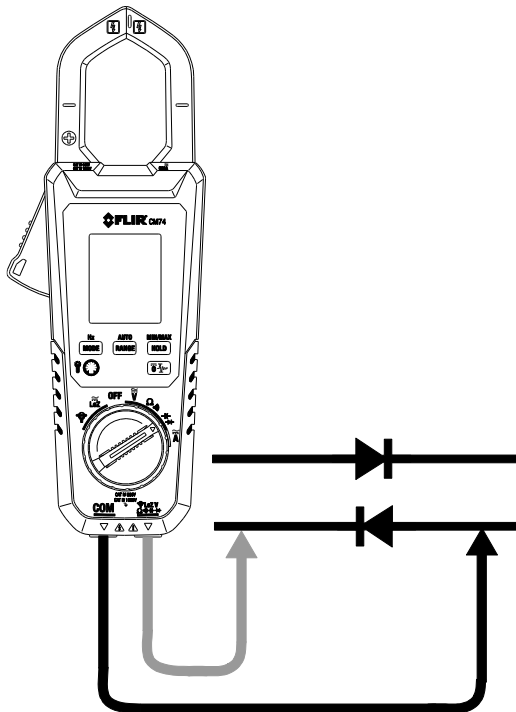

Figure 5.7 Diode Tests

## 6. Maintenance

---

### 6.1 Cleaning and Storage

Clean the meter with a damp cloth and mild detergent; do not use abrasives or solvents.

If the meter is not to be used for an extended period, remove the batteries and store them separately.

### 6.2 Battery Replacement

1. To avoid electrical shock, disconnect the meter if connected to a circuit, remove the probe leads from the terminals, and set the function switch to the OFF position before attempting to replace the batteries.
2. Unlock and remove the battery compartment cover.
3. Replace the four (4) standard AAA batteries, observing correct polarity.
4. Secure the battery compartment cover.

#### 6.2.1 Disposal of Electronic Waste

As with most electronic products, this equipment must be disposed of in an environmentally friendly way, and in accordance with existing regulations for electronic waste.

Please contact your FLIR Systems representative for more details.

## 7. Specifications

---

### 7.1 General specifications

Display counts:	0~6000
Measuring rate:	3 times per second
Over-range indication:	OL or –OL.
Auto power off:	10 minutes (can be disabled)
Low battery indicator:	 is displayed. Replace battery when indicator appears.
Power requirement:	4 × 1.5 V AAA alkaline batteries.
Battery life:	Approx. 200 hours for CM72; 65 hours for CM74 (with alkaline batteries and backlight/work light off)
Calibration:	1 year calibration cycle.
Operating conditions:	14 to 50°F (-10 to 10°C) (non-condensing) 50 to 86°F (10 to 30°C) (≤ 80% RH) 86 to 104°F (30 to 40°C) (≤ 75% RH) 104 to 122°F (40 to 50°C) (≤ 45%RH)
Storage conditions:	4 to 140°F (-20 to 60°C); 0–80% RH (batteries not installed)
Dimensions:	(D × W × L): 1.7 × 3.5 × 9.5 in. (43 mm × 89 mm × 241 mm)
Weight CM72:	12.8 oz. (363g) including batteries
Weight CM74:	15.0 oz. (426g) including batteries
Temperature coefficient:	0.2 × (specified accuracy)/°C, <64.4°F (18°C), >82.4°F (28°C)
Over-voltage category:	IEC 61010-1 CAT IV-600 V, CAT III-1000 V, IEC 61010-2-033

CAT	Application field
III	Distribution circuits, machinery, main switching devices close to switchgears, industrial installations and high current close to distribution circuits
IV	Installation sources, utility transformers, all outside conductors, counters, protective devices on primary sides and electricity meters

Operating altitude:	6562' (2000m)
Jaw opening:	1.38in. (35mm)
Pollution degree:	2

## 7.2 Electrical specifications

Accuracy is  $\pm$  (% reading + number of digits (dgt)) at 73.4 °F  $\pm$ 9 °F (23°C  $\pm$ 5 °C), <80% RH.

**Table 7.1 Voltage (TRMS)**

Function	Range	Accuracy (of reading)
DCV	60.00 V	$\pm$ (1.0% + 5 dgt)
	600.0 V	
	1000 V (CM74)	
ACV (CM72 only)	60.00 V	$\pm$ (1.0% + 5 dgt) 45~400 Hz
	600.0 V	
ACV VFD (CM74 only)	60.00 V	$\pm$ (1% + 5 dgt) 45~65 Hz $\pm$ (5% + 5 dgt) 65~400Hz
	600.0 V	
	1000 V	
Lo Z (Low Impedance)	60.0V AC/DC	AC: $\pm$ (1.0% + 5 dgt) 45~400 Hz (CM72) AC: $\pm$ (1.0% + 5 dgt) 45~65 Hz (CM74) AC: $\pm$ (5.0% + 5 dgt) 65~400 Hz (CM74) DC: $\pm$ (1.0% + 5 dgt)
	600.0V AC/DC (CM72)	
	1000V AC/DC (CM74)	

### Notes:

*LCD Displays '0' counts when the AC reading is <10 counts*

*CM72 Overload protection: 600 V (rms)*

*CM74 Overload protection: 1000V (rms)*

*Input impedance: 10 M $\Omega$  //, <100 pF*

*Lo Z Input impedance: 2.5k $\Omega$*

*AC conversion type: AC coupled, true RMS responding, calibrated to the RMS value of a sine wave input.*

*Accuracies are given for sine waves at full scale and non-sine waves below half scale.*

*If the meter measures a 4000-count signal and the Crest Factor of the signal is more than 3.0, the reading may not meet specified tolerances. For non-sine waves (50/60 Hz), add the following Crest Factor corrections:*

- *For a crest factor of 1.0–2.0, add 3.0% to the accuracy.*
- *For a crest factor of 2.0–2.5, add 5.0% to the accuracy.*
- *For a crest factor of 2.5–3.0, add 7.0% to the accuracy.*

**Table 7.2 Current (TRMS)**

Function	Range	Accuracy
DCA (CM74 only)	60.00 A	± (2% + 5 dgt)
	600.0 A	
ACA (CM72)	60.00 A	± (2% + 5dgt) 45~65Hz ± (3% + 5dgt) 65~400Hz
	600.0 A	
ACA VFD (CM74 only)	60.00 A	± (2% + 5 dgt) 45~65Hz ± (6% + 5 dgt) 65~400Hz
	600.0 A	

Notes:

*CM72: No VFD Mode and ACA Only*

*CM74: Integrated VFD Mode always ON in ACA MODE*

*Overload protection: 600A (rms)*

*Position Error: ±1% of reading for CM74 (CM72 not specified).*

*AC Conversion Type and additional accuracy is same as AC Voltage.*

*DCA affected by the temperature and residual magnetism; use DCA Zero function to compensate.*

*AC conversion type: AC coupled, true RMS responding, calibrated to the RMS value of a sine wave input.*

*Accuracies are given for sine waves at full scale and non-sine waves below half scale.*

*If the meter measures a 4000-count signal and the Crest Factor of the signal is more than 3.0, the reading may not meet specified tolerances. For non-sine waves (50/60 Hz), add the following Crest Factor corrections:*

*For non-sine waves (50/60 Hz), add the following crest factor corrections:*

- *For a crest factor of 1.0–2.0, add 3.0% to the accuracy.*
- *For a crest factor of 2.0–2.5, add 5.0% to the accuracy.*
- *For a crest factor of 2.5–3.0, add 7.0% to the accuracy.*



**Table 7.3 Frequency**

Function	Range	Accuracy
Frequency	600.0 Hz	± (0.1% + 2 dgt)
	6.000 kHz	
	60.00 kHz	

Notes:

*These frequency specifications also apply to 'Lo Z' Frequency measurements*

**Overload protection:** CM72: 600Vrms and 600 A (rms); CM74: 1000Vrms and 600 A (rms)

**Trigger Sensitivity:**

>5Vrms for ACV 10Hz~10kHz

>15Vrms for ACV 10kHz~60kHz

>4Arms for ACA 10Hz~10kHz

>8Arms for ACA 1kHz~10kHz (CM74 only)

Reading will be 0.0 for signals below 10.0 Hz.

**Table 7.4 Inrush current (CM74 only)**

Function	Range	Accuracy
ACA inrush	60.00 A	± (3% + 0.3 A)
	600.0 A	± (3% + 5 dgt)

*Inrush current detection threshold: 0.5A for 60A range and 5.0A for 600.0A range*

*Overload protection: 1000 Vrms, 600 A (rms)*

*Integration time is 100 ms*

**Table 7.5 Resistance and continuity and diode**

Function	Range	Accuracy
Resistance	600.0 $\Omega$ (CM74 only)	$\pm$ (1.0% + 5 dgt)
	6000 $\Omega$ (6.000k $\Omega$ for CM74)	
Continuity	600.0 $\Omega$	$\pm$ (1.0% + 5 dgt)
Diode	1.5V	$\pm$ (1.5% + 5 dgt)

*CM72 Overload protection: 600 V (rms).*

*CM74 Overload protection: 1000 V (rms).*

*Maximum test current: Approx. 0.1 mA.*

*Maximum open circuit voltage for  $\Omega$ : Approx. 1.8 V.*

*Maximum open circuit voltage for diode: Approx. 1.8 V.*

*Continuity threshold: < 30  $\Omega$  beeper on; > 150  $\Omega$  beeper off.*

*Continuity indicator: 2.7 kHz tone buzzer.*

*Continuity response time: <100 ms.*

**Table 7.6 Capacitance**

Function	Range	Accuracy
Capacitance	1 $\mu$ F to 1000 $\mu$ F	$\pm$ (1.0% + 4 dgt)

*CM72 Overload protection: 600 V (rms).*

*CM74 Overload protection: 1000 V (rms).*

**Table 7.7** Flex Clamp Adaptor Function

Function	Range	Accuracy
Flex (ACA)	30.00 A	$\pm (1\% + 5 \text{ dgt}) 45 \sim 400\text{Hz}$
	300.0 A	
	3000 A	

LCD displays '0' counts when the reading is < 10 counts

Additional accuracy for the Flex function is listed in the FLIR clamp adaptor User Manuals (Models TA72\_TA74).

**Table 7.8** Flex Clamp Adaptor Function (Frequency)

Function	Range	Accuracy
Frequency (Flex)	600.0 Hz	$\pm (0.1\% + 2 \text{ dgt})$
	6.000 kHz	
	10.00 kHz	

Sensitivity: >4A (rms) for ACA 10Hz ~ 10kHz.

## **8. Technical Support**

---

<b>Technical Support Website</b>	<a href="http://support.flir.com">http://support.flir.com</a>
----------------------------------	---

## **9. Warranties**

---

### **9.1 Limited Lifetime Warranty**

This product is protected by FLIR's Limited Lifetime Warranty. Visit [www.flir.com/testwarranty](http://www.flir.com/testwarranty) to read the Limited Lifetime Warranty document.



---

## Corporate Headquarters

FLIR Systems, Inc.  
27700 SW Parkway Avenue  
Wilsonville, OR 97070  
USA

## Customer Support

Technical Support Website <https://support.flir.com>

Publication Identification No.: CM72\_CM74

Release Version: AC

Release Date: May 2020

Language: en-US